



WE KEEP IT MOVING

PPI PRODUCTS

COMPLETE LINE OF CONVEYOR COMPONENTS AND SERVICES



PROVIDING EFFECTIVE CONVEYOR SOLUTIONS

Operations around the world demand efficient and reliable systems to keep business running. Today's customers are looking to reduce cost by minimizing downtime and system failures. They want components they can count on when they need them, now.

Offering designs specific to your needs you can trust PPI to deliver the latest in high performance conveyor components for all applications.

Our promise is simple, provide quality products with a competitive price and unbeatable customer service.

Whether the requirements of your operation are underground or above, PPI is your ally supplying components that will outperform expectations and support your productivity goals from start to finish.

WE KEEP IT MOVING®

TABLE OF CONTENTS

3-5	Specialty Drum Pulleys
6	Wing Pulleys
7	Pulley Lagging
8	Unit Handling Pulleys and Rollers
9	Hubs, Bushings, Bearings and Shafting
10	Take-Up Frames
11	CEMA Class Idlers
12	Carrier and Return Idlers
12	Belt Tracking Idlers
13	Idler Accessories
14	Conveyor Structures
15	Retro Rolls®
15	Monitoring Equipment
16	Impact Systems
17	Stainless Steel Components

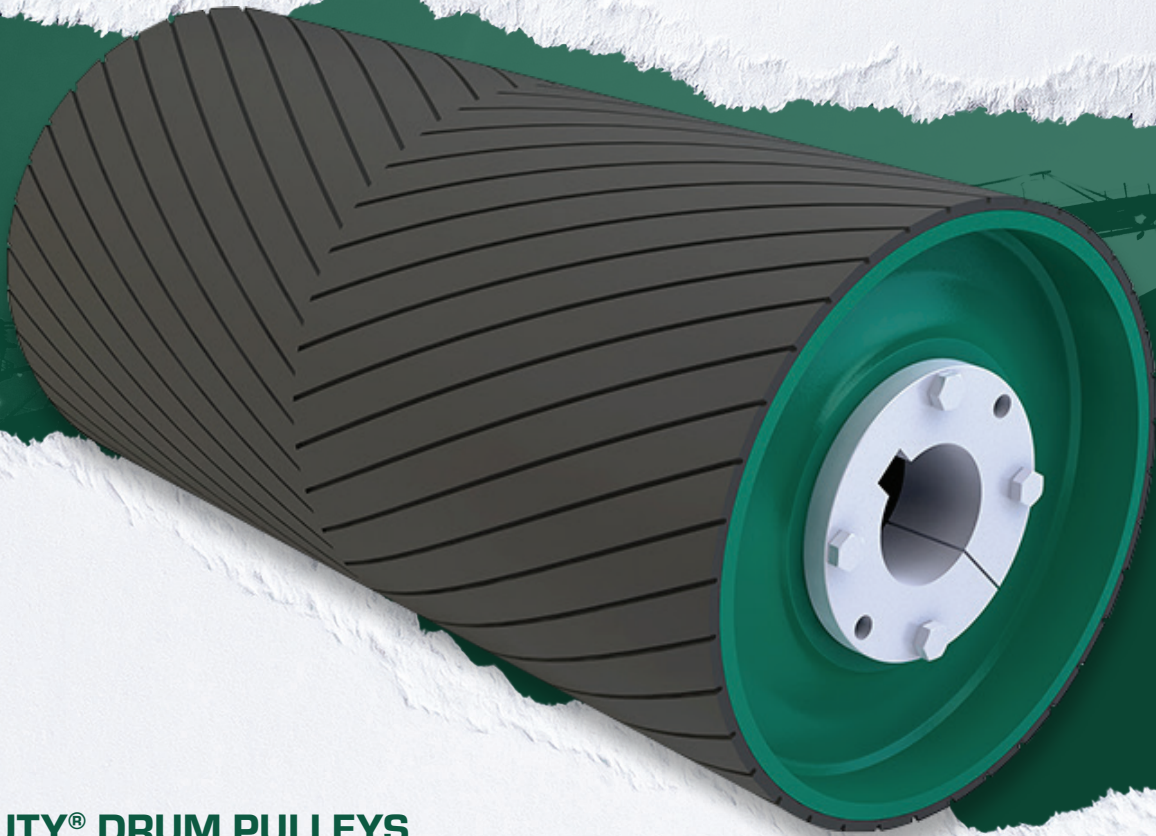

PRO DUTY® DRUM PULLEYS

A single drum pulley line that can be used everywhere from the everyday light aggregate conveyor to the toughest quarry-duty application. No more guessing which pulley you need because the Pro Duty covers them all.

The Pro Duty drum features profiled end disc technology most commonly used in turbine pulley designs. The profiled end discs are machined from solid steel with an integral hub rather than using a welded hub which conventional pulley construction uses. Removing this welded hub eliminates the most common cause of pulley failure. In addition, the tapered profile end disc shape reduces the bending force transferred from the shaft into the pulley. It also reduces the stress on the bushings and welded joints. These design features all work together to achieve a dramatic increase in service life when compared to a conventional welded hub pulley.

THE ONLY PULLEY WITH A 10-YEAR WARRANTY

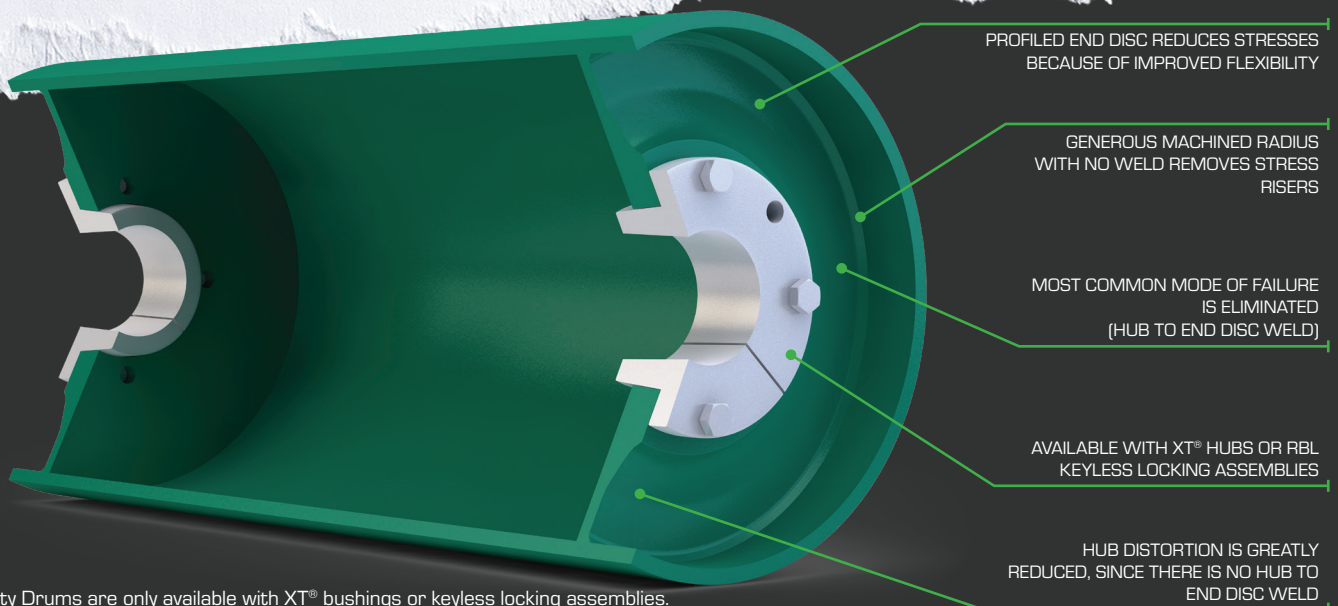

Note: Pro Duty Drums are only available with XT® bushings or keyless locking assemblies. 10 year warranty covers ProDuty Pulley only; lagging, shafting or bearings are not included.

DRUM PULLEYS

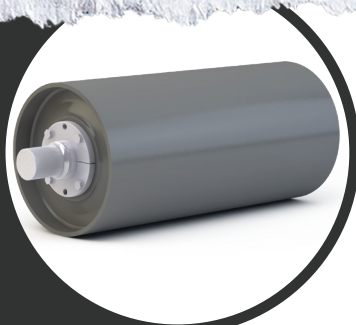

ENGINEERED CLASS DRUM CONVEYOR PULLEY

Bulk handling systems are moving to larger conveyors and increased capacities. The high modules, high tension belts require pulleys of much higher capacity and durability than standard units. PPI has the experience, know-how, and equipment to custom design and fabricate pulleys for each pulley location and application. PPI Engineered Class pulleys are supplied with various hub and bushing systems including keyless locking devices which are common on high tension steel cable belt systems.

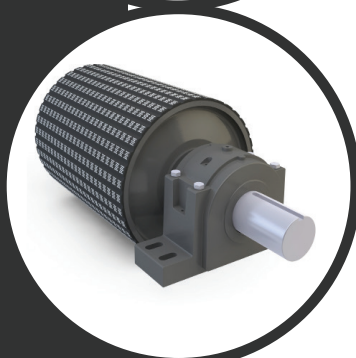

TURBINE PULLEY

Today's efficient high tonnage mines demand dependable long-lasting components. Using state of the art engineering and design techniques, such as Precision Finite Element Analysis, PPI meets these needs by controlling material stress points. Incorporating all of the benefits of PPI's proven experience in heavy mining pulleys, the turbine offers our customers world class performance and reliability.

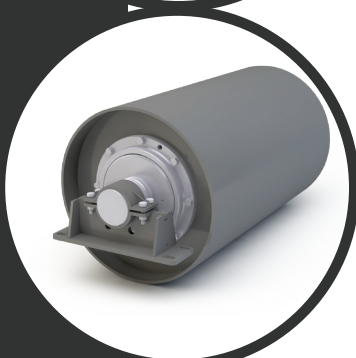

STATIC SHAFT PULLEY (SSP®)

The SSP is a problem-solving solution for pulley applications prone to frequent bearing failure. Having bearings mounted inside the pulley hub provides exceptional bearing protection. This patented design also uses a taconite sealing system that provides further protection from contaminants entering the bearing.

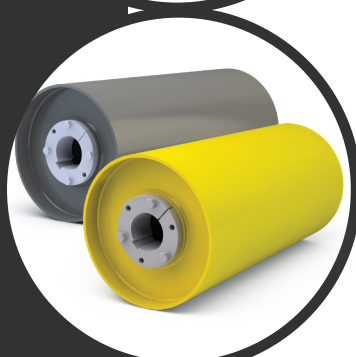

HEAVY DUTY DRUM (HDD) CONVEYOR PULLEY / MINE DUTY DRUM (MDD) PULLEY

Heavy Duty Drum (HDD) conveyor pulleys are made with steel rims, hubs and discs are fused into an integral component by a continuous submerged arc welded bond that maximizes pulley strength, balance and concentricity. The HDD is available with various hub and bushing systems.

PPI Mine Duty Drum pulleys incorporate heavier rims and end discs for increased service life and safety. Suited for more demanding applications, such as frequent starts and stops with a loaded belt or where increased reliability is desired.

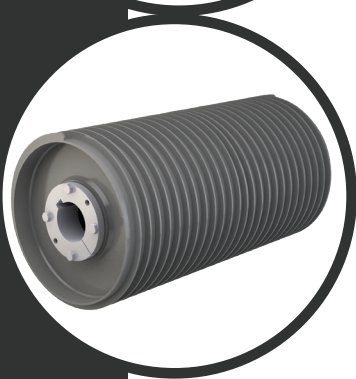

SPIRAL DRUM CONVEYOR PULLEY

The PPI Spiral Drum pulley is formed by a pair of vertical steel bars helically wound around a Heavy Duty Drum (HDD) pulley. This unique design is frequently used when additional cleaning action is desired without introducing additional belt vibration. Rotation of the pulley automatically starts the cleaning action by discharging foreign material to the side of the conveyor. Available in crown or straight face and also with various hub and bushing systems.

SINGLE DISC ELEVATOR (SDE) PULLEY

Used primarily in the grain industry, the SDE Pulley is continuously welded to the rim on both sides of the disc. Its heavy-duty construction and a high compression hub and bushing affords a one piece all steel, single disc pulley capable of reducing stress and deflection.

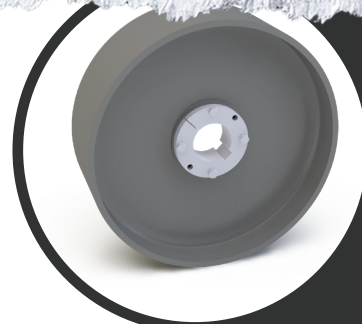

DEFLECTION WHEELS

PPI Deflection Wheels are designed for the deflection of corrugated side wall belting. Cross rigidized base belting with corrugated sidewalls can be deflected from horizontal to any incline and back again with PPI Deflection Wheels. We will build to your specification or we can design it for a given application.

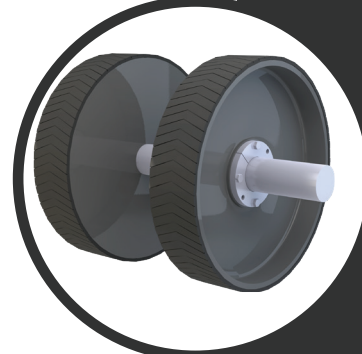

EZ MOUNT PULLEY SYSTEM

EZ Mount is a unique pulley and shaft system allowing fast and economical bearing and shaft replacement without removing the pulley from the conveyor. It reduces maintenance and replacement time by using rugged engineered stub shafts.



PULLEY ASSEMBLIES

For maximum efficiency and added value, PPI is your single source for conveyor pulley assemblies. PPI can provide pulley lagging, shafting, bearings and Take Up Frames to complete the pulley package. Couplings, backstops and other components can also be mounted upon request.

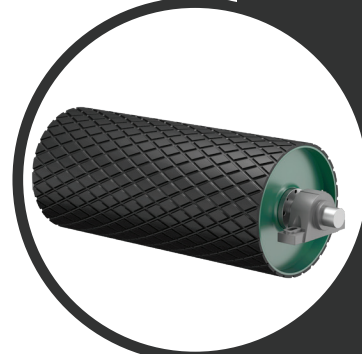

PADDLE WHEEL

PPI's Paddle Wheel offers a simple solution for material segregation. As material is conveyed the fine particles settle to the bottom of the conveyor while large coarser product remains at the top. This separation of material causes segregation of traditional conical stock piles leading to product being out of specification. PPI's Paddle Wheel is mounted at the discharge point of the conveyor and agitates the material as it is ejected from the conveyor minimizing material segregation of the stock pile.

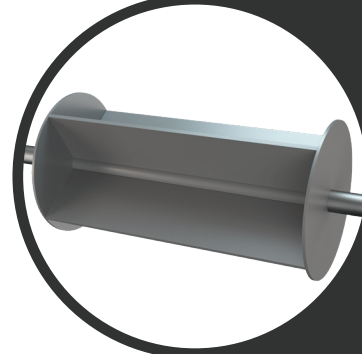

WING PULLEYS



HERRINGBONE WING® CONVEYOR PULLEY

The PPI Herringbone Wing® was designed for applications where conventional wings suffer from excessive material lodging and wing folding. The extreme wing angles of up to 45 degrees use the pulley's rotation to eject material out the sides of the pulley rather than recirculating it, as a conventional wing often does. PPI Herringbone Wing® is also available in a CEMA version.

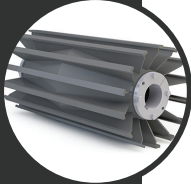

HEAVY DUTY WING (HDW) CONVEYOR PULLEY

Pulley and belt life are extended by the self-cleaning action employed by the PPI Heavy Duty Wing pulley. Individual, all steel wings and gussets expel excessive buildup of material from the area of belt contact which enhances traction and reduces abrasion of both the belt and pulley.

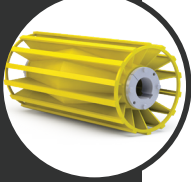

MINE DUTY WING (MDW) CONVEYOR PULLEY

Demanding wing pulley applications call for PPI Mine Duty Wing pulleys. Mine Duty Wing pulleys provide effective self-cleaning action that reduces excessive material build up. The extra heavy duty construction reduces the possibility of metal fatigue and enhances the dependability of the pulley. Ideally suited for harsh applications and very abrasive conditions.

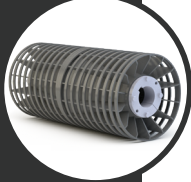

SPIRAL WING CONVEYOR PULLEY

The PPI Spiral Wing and Spiral Plus Wing pulleys are formed by winding flat bar spirally from the center of a wing pulley to the outside ends. This continuous belt contact design eliminates excessive noise and vibration, while still providing a cleaning effect and allowing a path for debris to escape rather than being trapped between the pulley and belt.

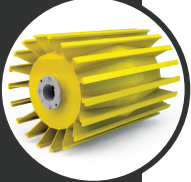

QUARRY MAX DUTY WING CONVEYOR PULLEY

The Quarry Max Duty Wing pulley is made for severe applications where wing folding and abrasion issues are a concern. It has massive contact bars and thick wings. The Quarry Max Duty Wing resists wing folding by utilizing an end disc when necessary to keep wing heights ideal, short enough to resist folding and long enough to provide adequate rigidity.

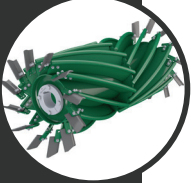

GRAIN HERRINGBONE WING® CONVEYOR PULLEY

PPI's Grain Herringbone Wing combines improved wear, quieter operation and gentle grain handling compared to standard wing pulleys. It has more wings to support thin grain belting and it has rubber flappers to lift grain and throw it back onto the belt in enclosed conveyors.



BOOT HERRINGBONE WING CONVEYOR PULLEY

The patented PPI Boot Herringbone Wing® pulley combines improved wear, quieter operation and gentle grain handling, along with a sensor ring for use with proximity or heat sensors.



CONTINUWING® TECHNOLOGY

Extending pulley life in highly abrasive applications has been a challenge in the conveying industry. PPI's ContinuWing technology incorporates unmatched wear resistance with our existing herringbone and conventional wing pulley offerings. Utilizing proprietary manufacturing processes, chromium carbide replaces traditional mild steel or AR alloys used on the face of wing pulleys. ContinuWing Technology will dramatically extend the life expectancy of a pulley, reducing costly maintenance and downtime.

PULLEY LAGGING

PPI has complete in-house pulley lagging capabilities. Every step of the pulley manufacturing and lagging process is controlled internally, which assures quality, prompt delivery and competitive pricing of lagged pulleys. Available in a wide variety of styles and thicknesses, lagging is primarily used to improve traction capabilities, resist abrasive conditions and extend pulley and belt life. The style of lagging required is usually influenced by operating conditions. While the standard is 60 durometer, it is available in various durometers, with 50 and 70 being the common alternatives. SBR is standard; neoprene, durometer and MSHA are available as well as a wide variety of other compounds.

Other lagging is available for specific applications. An example of this is ROUGHTOP LAGGING. This is used for small diameter drive pulleys. It is created by lagging the pulley, but before the rubber is cured, a special mold is applied to the lagging to cause the grooves to be formed in the lagging. It is cured with this form in place. It gives excellent traction, without cutting grooves. By forming the groove in the lagging, PPI can offer Roughtop on thin lagging, such as 1/4". Consult your sales representative for specific requirements.



HERRINGBONE GROOVE LAGGING (HBG)

The style of lagging required is usually influenced by operating conditions. This style of grooving is where the points do not meet in the middle. This is normally used in drive pulleys, with the V pointing in the direction of rotation. (3/8" minimum thickness)



CHEVRON GROOVE LAGGING (CHE)

Similar to the herringbone style, we offer chevron based on customer preference. This is also used primarily on drive pulleys. (3/8" minimum thickness)

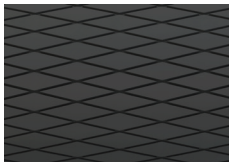

DIAMOND GROOVE LAGGING (DIA)

Diamond, or double HBG, or double chevron is primarily used for reversing conveyor drive pulleys. It is also often used for spare pulleys when one doesn't know the direction of rotation. (3/8" minimum thickness)



CIRCUMFERENTIAL GROOVE LAGGING (CIR)

This is used on non-drive pulleys for really wet applications or cold temperatures, which allows the lagging to deflect, keeping material from building up on the lagging. (3/8" minimum thickness)

ALIGNER GROOVE LAGGING (LOR)

This is a Lorig™ style lagging and is used on flat face pulleys. The lagging is machined flat, then grooves are machined in at an angle. This results in a training action. As the rubber is compressed by the belt, the lagging will deflect towards the center, helping to track the belt. (3/4" normal thickness)



CERAMIC LAGGING

Ceramic lagging has ceramic tiles molded into a rubber compound. This makes for excellent traction, reduced slippage and offering excellent abrasion resistance.



VULCANIZED ENGINEERED CERAMIC LAGGING (VEC)

Our patented VEC Lagging starts with SBR or neoprene lagging that is hot vulcanized on a pulley. Our uniquely designed tiles are then embedded in the vulcanized lagging. This design eliminates seams, where failures often start. This process allows flexibility in tile coverage and grooving patterns as well.



CRAFT-LAG®/EZ LAG

Craft-Lag and EZ lag are field replaceable lagging. Craft-Lag is bonded to rigid backing, then formed to a specific diameter. Craft-Lag can be used with or without retainers and is ideal for mining, crushed stone, sand and gravel, cement, agriculture, food processing, coal mining, power plants, feed and grain and general industry.

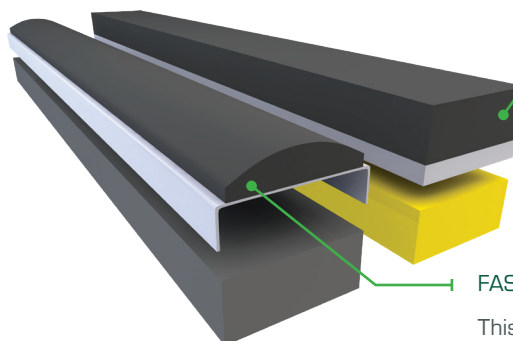
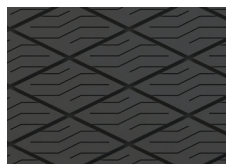

XHD FAS-LAG® REPLACEABLE LAGGING

This easy to install wing pulley lagging system is designed for the Quarry Max Duty Wing pulley. It is welded to the flat contact bar to provide additional traction with the belt and added protection for the contact bar and protection for the mechanical splice. The lagging is 2" wide by 1" thick to provide an extended life. The standard is black 60 durometer SBR.

FAS-LAG® FLAT REPLACEABLE LAGGING

This easy to install wing pulley lagging system is designed for original pulley lagging. It is welded to flat contact bar to provide additional traction with the belt and added protection for the contact bar and protection for the mechanical splice. The standard is black 60 durometer SBR. It can be provided with other compounds and colors.

UNIT HANDLING PULLEYS AND ROLLERS



UNIT HANDLING PULLEYS AND ROLLERS

Unit handling applications typically have a diameter range from 2" - 16". With wall thickness ranging from 14 gauge to 1/2" depending on conveyor load requirements.



WELD IN:
Plain bore without hub



ADAPTER TYPE:
Detachable tapered bushing



ROLLER:
Fixed shaft with internal bearings

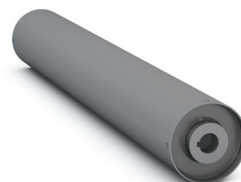

FIXED BORE:
Finished fixed bore hub with standard key seat

HUBS, BUSHINGS, BEARINGS AND SHAFTING

HUBS AND BUSHINGS

PPI offers a wide range of hub and bushing systems for proper mounting of pulley to shaft, including XT[®] hubs and bushings (maximum bore 12"), QD[®] hubs and bushings (maximum bore 12") and keyless locking assemblies up to 23.622". Other options, such as press fit and solid bore mounting are available upon request. Hubs and bushings are also available separately.

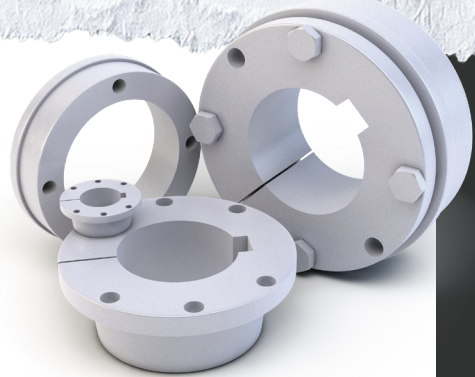

SHAFTING

PPI conveyor pulley shafting is a vital part of the total pulley assembly. Standard PPI shafting is AISI 1045. The higher carbon content is an AISI 1045 results in a very strong steel that machines to a smooth finish. Normally, PPI uses T&P for shafting up through 5-15/16". Hot rolled and/or forged shafting (depending upon size, availability and specifications) is used above a 6" diameter.

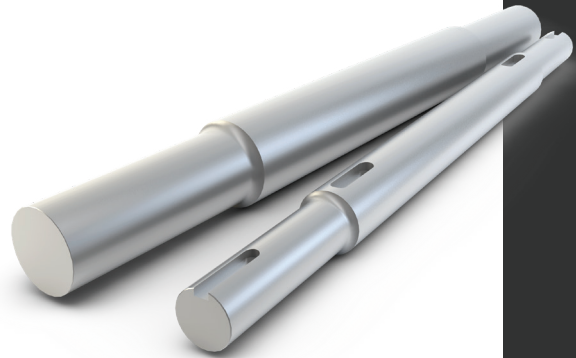

BEARINGS

We had severe conveyor conditions in mind when developing our line of PPI pillow block bearings. That's why we designed our PPI Type E bearing with a double row spherical bearing that allows a misalignment of ± 2 degrees, and a double lip nitrile contact seal that effectively protects from contaminant entry.

Our heavy duty SAF, SDAF, SN and SD adapter mount pillow block bearings are ideally suited for heavy conveyor applications. They use large double row spherical bearings, robust housings in various materials such as cast iron, ductile iron and cast steel, along with different seal options.

For those applications where a more economical ball bearing pillow block is called for, we have a durable SCM bearing with a nitrile contact seal that has proven effective in the contaminated environments that are common in our industry.

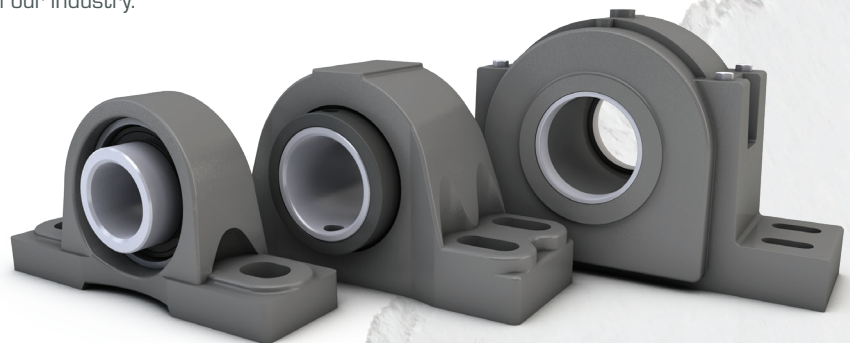

TAKE-UP FRAMES

Take-Up Frames eliminate the need for additional take-up supports and enable load distribution. PPI offers a number of different styles and options for your specific needs.



SLIDE TUBE (PST) TAKE-UP FRAMES

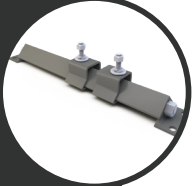

LIGHT DUTY (PLD) TAKE-UP FRAMES



MEDIUM DUTY (PMD) TAKE-UP FRAMES



HEAVY DUTY (PHD) TAKE-UP FRAMES



TOP ANGLE (PTA) TAKE-UP FRAMES



PROTECTED ANGLE (PPA) TAKE-UP FRAMES

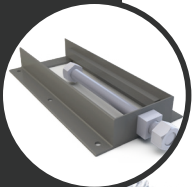

WIDE SLOT (PWS) TAKE-UP FRAMES



CENTER PULL (PCP) TAKE UP FRAMES

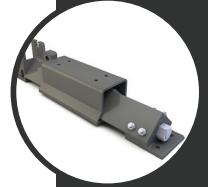

HEAVY DUTY HYDRAULIC (PHYD) TAKE UP FRAMES



HYDRAULIC CYLINDER (HYD)



HYDRAULIC HAND PUMP

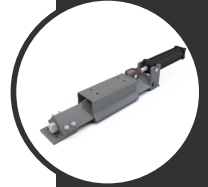

HYDRAULIC CYLINDER KITS

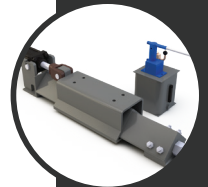

HYDRAULIC CYLINDER KITS WITH PUMP

PPI's full line of idlers meet or exceed CEMA requirements for load, life and dimensions. They are designed and manufactured for long trouble free life with no greasing.

TROUGHING IDLERS (TE)

PPI Idlers are available in CEMA B, CEMA C, CEMA D, CEMA E and CEMA F series.



IMPACT TROUGHING IDLERS (TEI)

PPI Impact Idlers are built with heavy duty frames to withstand shock at the loading zone.



SELF-ALIGNING TROUGHING IDLERS (TESA)

PPI Self-Aligning Idlers are built to the same specifications as troughing idlers. The frame is mounted on a separate base with tapered roller bearings and is free to swivel within controlled limits. The side guide rolls can be universally mounted on either side for belt travel in either direction or centered at the roll ends for reversing belts.



UNEQUAL TROUGHING IDLERS (TU)

PPI Unequal Idlers (or picking idlers) are available for special conveyors where the product is spread over a flat belt with the side turned up to prevent spillage.



UNEQUAL IMPACT TROUGHING IDLERS (TUI)

PPI Unequal Impact Idlers are built to withstand the shock at the loading zone.



TRANSITION EQUAL TROUGHER IDLER (TET)

Providing a smooth transition from a flat belt to a troughed belt or vice versa is critical in promoting long life of the components in the transition area and most importantly, extending belt-life.



HDPE IDLER ROLLS (PL)

High Density Polyethylene (HDPE) rolls incorporate our field proven seal system that provides outstanding contamination resistance extending the life of the roll.

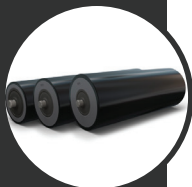

SPINWELD HDPE IDLER ROLLS

Spinweld High Density Polyethylene (HDPE) rolls serve the market by offering several key benefits: significant weight reductions compared to their steel equivalents; great corrosion resistance; excellent wear and abrasion characteristics; and reduction in noise levels.



SPINWELD NYLON IDLER ROLLS

Nylon rolls offer many of the same characteristics as other polymer rolls such as: significant weight reductions compared to their steel equivalents; great corrosion resistance; excellent wear and abrasion characteristics; and reduction in noise levels.



RETRACTABLE FRAME IDLERS (RET)

PPI's Retractable Frame Idlers are an excellent choice for impact zones where frequent roll change-out is required.



REMOVABLE END BRACKET

Roll maintenance and replacement can be a very challenging task with traditional troughing idler frames. Incorporating PPI's removable end bracket frames to high wear areas—like loading zones—can ease the job by allowing the user better access to idler rolls in a congested area.

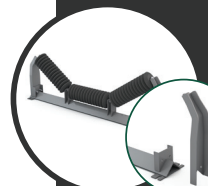

GRAIN IDLER

Designed to protect the lightweight belting that is typically used in the grain industry, PPI's Grain Idler incorporates an offset center roll design. By offsetting the center roll relative to the wing rolls it eliminates the pinch point, protecting the most expensive piece of the conveyor system, the belt.



CHANNEL INSET TROUGHING IDLERS (CIT)

Designed for between frame mounting, PPI offers this frame for use where vertical clearance is minimal. This style meets CEMA load requirements and is available in both CEMA B (14"-48") and CEMA C (24"-60") with 4" and 5" diameter rolls.



ALUMINUM ROLLS

Offering a significant weight reduction compared to equivalent steel rolls, this roll makes maintenance work easier. Incorporated with heavy wall tube and PPI's proven seal design, the Aluminum Roll eases maintenance while maintaining CEMA load ratings.



CARRIER/RETURN & BELT TRACKING IDLERS

Belt tracking is critical to maintain both the belt and structure. Not all belt-tracking issues respond to the same component, which is why PPI offers multiple options and solutions to meet specific application requirements.

FLAT CARRIER IDLERS (F)

PPI Flat Carrier Idlers are constructed to the same specifications as troughing idlers. The support bracket's strength is equal to or greater than the idler load rating.

RUBBER DISC FLAT CARRIER IDLERS (FRD)

Rubber Disc Flat Carrier Idlers are made of abrasion resistant, synthetic rubber with a compression fit between a heavy wall tube and the disc. Generally used for applications where sticky material builds up on traditional steel idlers.

RETURN IDLERS (R)

PPI Return Idlers are available with 4 1/2" drop brackets unless 1 1/2" drop brackets are requested.

RUBBER DISC RETURN IDLERS (RRD)

Rubber Disc Return Idlers are constructed from abrasion resistant, synthetic rubber discs. Generally used for applications where sticky material builds up on traditional steel idlers.

RETURN RUBBER GROOVED IDLERS (RRG)

Possessing the same material shedding characteristics and wear properties of traditional rubber disc rolls, the Return Rubber Groove Roll (RRG) improves on an already great product.

LIVE SHAFT IMPACT IDLER (LSI)

PPI Life Shaft Impact idlers consist of rubber disc mounted on a solid steel shaft. Pillow block bearings are mounted on the turn down ends. PPI can provide pillow block bearings with the live shaft rolls.

BEATER BAR RETURN

Providing a vibratory belt cleaning action PPI's Beater Bar Return Roll knocks off material carryback from the conveyor belt.

REVERSE SELF-ALIGNING IDLER

Traditional self-aligning idlers will not function properly in reversing belt applications.

PPI's Reversible Self-Aligning idler is equipped with either a slider plate style or a guide roller version, both configurations operate under the same principle, as the belt wanders off of centerline it engages the actuators causing the trainer to steer the belt back to center.

SELF-ALIGNING RETURN IDLERS (RSA)

PPI Self-Aligning Return Idlers are comprised of a two piece frame with tapered roller bearings, and are free to swivel within controlled limits. The side guide rolls can be universally mounted on either side for belt travel in either direction.

SELF-ALIGNING FLAT CARRIER IDLERS (FSA)

All of the features that are designed into the Self-Aligning Troughing Idlers will be found in this idler.

INVERTED V-RETURN (IVR)

Inverted V-Return Idlers are used to positively track the belt on the return side of the conveyor. The IVR is adjustable to increase the displacement and the resulting tracking force on the belt. Operating on the clean side of the belt ensures material buildup on the rolls does not adversely affect the belt training.

V-RETURN (VR)

PPI's V-Return Idlers are available with 4.5" and 7" drop heights and are built with a 10° two roll trough configuration that allows gravity to naturally keep the belt centered. The shorter two roll design enables the user to implement much lighter rolls than traditional single roll configurations.

PRO TRAINER

Pro Trainer was designed to actively train a conveyor belt while operating on the clean side of the belt. Training a belt on the clean side offers significant advantages compared to traditional return self-aligners by eliminating the potential of material carry back building up on the roll negating the training characteristics.

PRO TRACKER

With continuous engagement on the clean side of the belt, this lagged return trainer pivots to guide the belt to its central position, resulting in less material loss and belt damage.

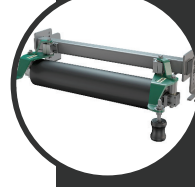
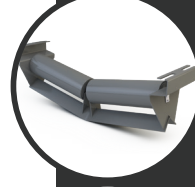
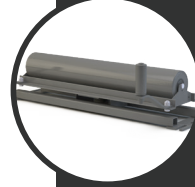
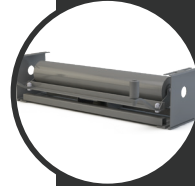
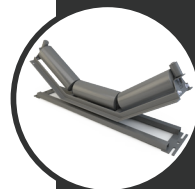



SPIRAL URETHANE ROLL

PPI's Spiral Urethane Rolls provide an ever-changing point of contact on the belt surface that allows cleaning action without beating the belt. The spiral design is made out of urethane which promotes extended wear qualities and abrasion resistance.

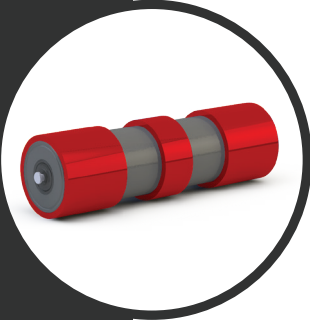

URETHANE SLEEVE ROLL

Utilizing PPI's standard steel return rolls, urethane sleeves are pressed on to the roll to provide an abrasion resistant surface for the return path of the belt. Material carryback on the belt often causes standard steel rolls build up with debris causing belt tracking issues and can lead to premature wear. Urethane material properties promote excellent abrasion resistance and its slick surface prevents material build up.



RETURN ROLL GUARD (RG)

The PPI Return Roll Guard provides a barricade at the pinch point created by the belt passing over a return roll. The 1 1/2" or 4 1/2" mounting brackets provide easy installation on 4", 5" or 6" rolls utilizing the return bracket's mounting bolts. While normally used on return rolls with seven feet or less vertical clearance from the ground or decking, it may be used on any return roll.

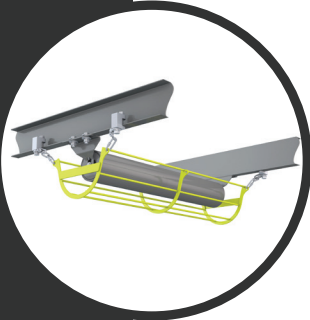

RETURN ROLL CAGE

Safety is so important for mining operations. PPI's Return Roll Cage provides protection to property and personnel from suspended idler rolls. As belts misalign, they may cut drop brackets of suspended return rolls causing the roll to fall. Installing a Return Roll Cage alleviates that risk by catching any dislodged roll.

CONVEYOR STRUCTURES



CONVEYOR COVER

PPI offers both full and three-quarter conveyor covers, standard in galvanized steel you can count on PPI Conveyor Covers to hold up to a multitude of environmental challenges.

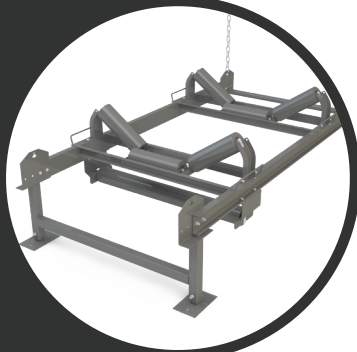

RIGID RAIL STRUCTURE

PPI is proud to offer conveyor structure to accompany our variety of loading capabilities. With bolt on or clamp on styles available, PPI is sure to have a product to meet your needs. Both structure types are available in CEMA C, D and E, and 30" to 60" belt widths. For wider belts, please call for application assistance.

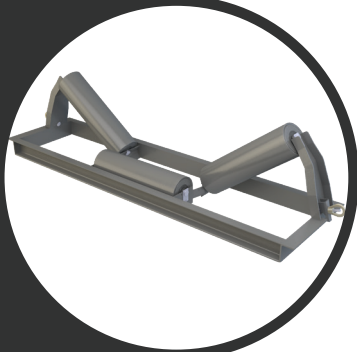

WIRE ROPE IDLERS

Designed primarily to be used in underground applications where ceiling heights can be quite limited, PPI Wire Rope Idlers incorporate an offset center roll design that minimizes overall profile height of the idler assembly. Outfitted with a universal clamp that provides versatile installation on wire rope applications or rigid rail systems.

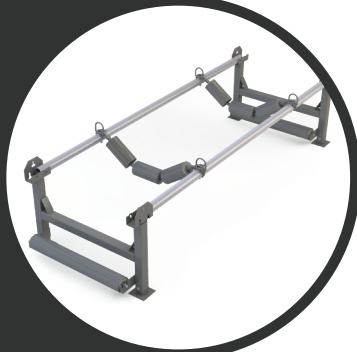

CATENARY STRUCTURE

PPI Catenary structure incorporates a user-friendly design that allows easy assembly and tear down that lets operators reconfigure conveyor as the mining process dictates. Floor stands equipped with chain-slot brackets allow roof or floor mount configurations based on specific terrain at the mine. Available in CEMA C, D and E for 24" - 60" belt widths. For wider belts, please call for application assistance.

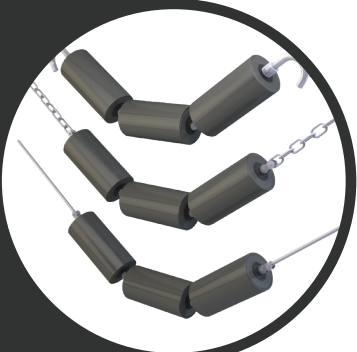

CATENARY IDLERS

Idler structure designs vary widely within the industry, so PPI has adapted the shaft ends of our idler rolls to accept a variety of mounting hardware ranging from hooks, chain and threaded rod. Having so many different mounting options available ensures PPI can retro fit our catenary idlers into most existing structures found in the market today.

RETRO ROLLS® & MONITORING EQUIPMENT

RETRO ROLLS

PPI Retro Rolls® allow you to use proven PPI idler rolls in other manufacturers' frames. You get the durability and low maintenance that PPI is known for without having to replace existing frames.

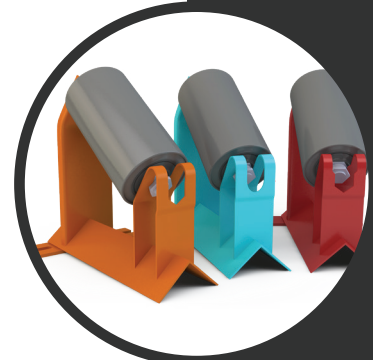

SMART ROLL

The PPI developed and patented Smart Roll monitors conveyor belt speed. Designed with a proximity sensor protected inside our rugged idler roll, it creates an electronic pulse stream that must be interpreted by either a PLC or our Smart Monitor. When those interpreting devices are incorporated into a conveying system, they can control motor shutdown circuits preventing material overflowing onto a broken down conveyor.



MAGNETIC SPEED SWITCH

PPI's Speed Switch design is setting the bar for ease of installation in the conveyor monitoring field. The innovative magnetic coupling system eliminates the conventional drill and tap of the past. Simply snap the sensor into place on the shaft, connect wiring and installation is complete. The magnetic coupling not only makes installation a breeze, it allows the unit to break away from the shaft if struck by errant debris, minimizing equipment damage compared to rigid designs.



WATCH DOG MONITOR

The Watch Dog timer relay is a single pole, double throw relay with a field adjustable timed input trigger. The relay is designed to monitor a pulse stream received from a speed monitoring device such as the PPI Magnetic Speed Switch and provide a continuously open or closed relay connection.

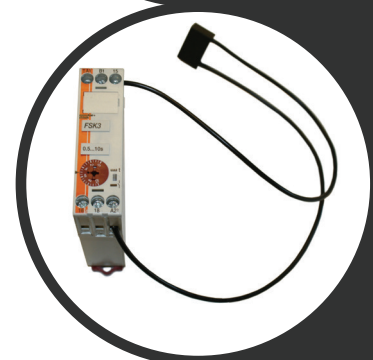

IMPACT SYSTEMS

TRUE IMPACT SYSTEM (TIS)



PPI True Impact System (TIS) solves the problem of sealing the skirt boards and the high impact upon the belt. By utilizing its proven impact rolls, along with a center support system that is cushioned against the frame, it gives the TIS its double action dampening system. This rugged five-foot bed is made from welded steel and fits D6 and E7 rolls. While the rolls are D6 or E7, it does come in a low profile version (TISL) that will line up with C5/D5 or an E6. The slider rails come with 1/2" thick Ultra High Molecular Weight (UHMW). This product is also available as a Channel Impact System (CIS).

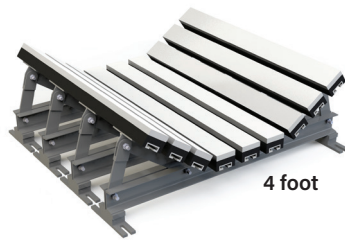
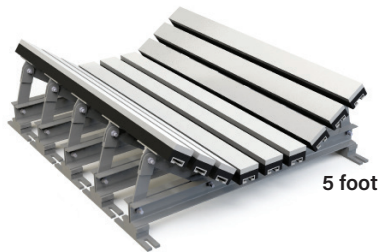

MEDIUM DUTY IMPACT SYSTEM

The PPI medium duty impact bed is a cost-effective solution for your impact and loading zone requirements. This bed is an ideal combination of impact absorption and belt support that promotes a tight seal against a skirting system. A modular design, available in two-foot, four-foot and five-foot lengths with foldable wings, allows the user to configure to their unique needs.

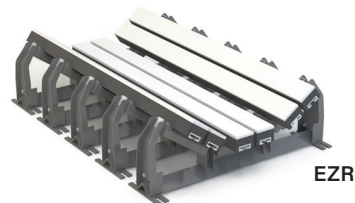

EZ SLIDER IMPACT SYSTEM

PPI's EZ Slider series provides a variety of loading zone options. The EZI is equipped with rubber disc rolls that provide impact absorption for light to medium duty loads. For applications beyond the loading zone, the EZS has steel idler rolls in the center position providing excellent load support. The EZR is a light duty slider bed that can be used in the loading zone and beyond, providing continuous support throughout the trough. All three versions are equipped with rails in the wing position to provide excellent support for skirt board sealing.

STAINLESS-STEEL COMPONENTS

PPI is a premier manufacturer of stainless-steel products for the food processing and unit handling industries. We now offer a complete line of stainless-steel conveyor drum and wing pulleys as well as custom stainless-steel machining capabilities for a wide variety of components to serve your operation's light-belt needs.

We have an excellent understanding of USDA and FDA requirements and have been building products for use in these applications with proven success. In addition to our stainless-steel machining, forming and welding services are also available for plastic materials including UHMW, Acetal and Ertalyte just to name a few.

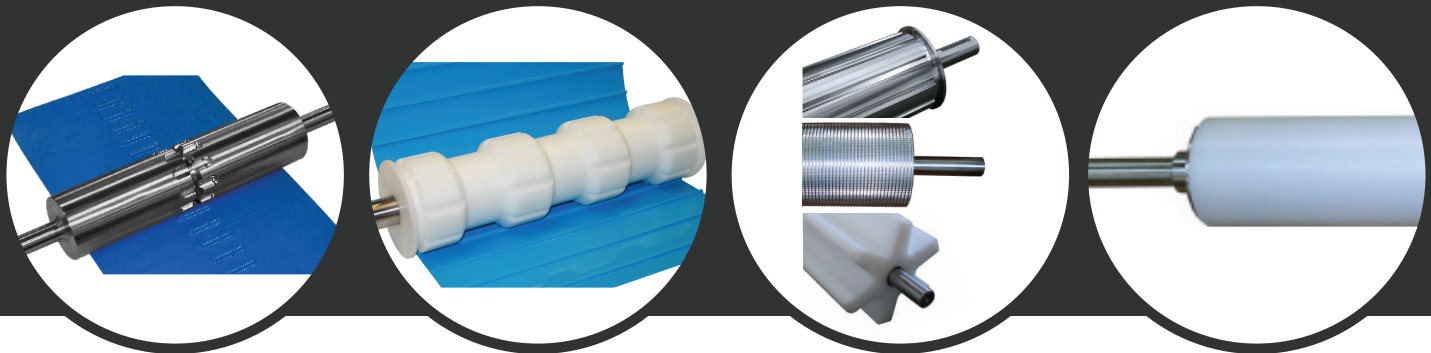

SELF-LEVELING FOOT PADS

Our Self-Leveling Foot Pads are an all stainless-steel, sanitary design that allows their use in food production applications.

They are available in a wide variety of standard sizes and lengths with load carrying capacities of up to 28,000 lb.

HUBS AND BUSHINGS

A pulley assembly is only as good as the components that go into it. That's why we make our own stainless-steel hubs and bushings. We control the quality of the raw materials and the machining tolerances that go into each one. Available in XT®, QD® and Taper-Lock®.

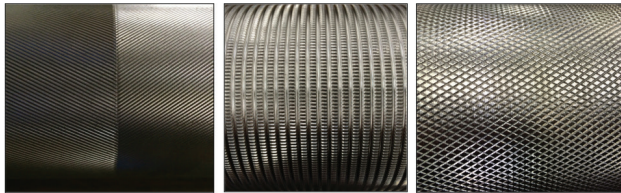



WWW.PPI-GLOBAL.COM | SALES@PPI-GLOBAL.COM

Product shown are for illustrative purposes only and may display optional accessories or components. Please contact your sales representative for more information on product specifications. PPI respectively reserves the right to make changes in engineering, design and specifications; add improvements; or discontinue manufacturing at any time without notice obligation. Craft-Lag, Fas-Lag, Herringbone Wing, Retro Rolls, P-FLEX, PPI, and their respective logos are trademarks of Precision, Inc. in the US and or other countries. Lorig is a trademark of US Steel. QD is a registered trademark of Emerson Electric. XT is a registered trademark of VanGorp Corporation. Taper-Lock is a registered trademark of Baldor Electric Company.