

Nylon rolls have found a niche in the market by offering several key benefits: significant weight reductions compared to their steel equivalents; great corrosion resistance; excellent wear and abrasion characteristics; and reduction in noise levels. Utilizing a spinweld production process combined with the material composition of Nylon tubing, allows these rolls to handle heavier loads than some of the other polymer rolls on the market.

FEATURES AND BENEFITS

- Utilizes spinweld technology to create the ultimate bond between the bearing housing and the tube
- Spinweld technology provides an impenetrable bond that keeps moisture and dust out of the roll
- Weight reductions of nearly 40% compared to steel roll equivalents
- Field proven seal design promotes long roll life by keeping contaminants out
- Machined surface provides exceptional T.I.R.
- Retro Roll capable

TECHNICAL SPECIFICATIONS

- Meets CEMA D dimensions
- Available in 5" diameter with 25mm shaft and 6" diameter with 30mm shaft
- Larger shaft and bearing options available
- 5/8" tube thickness
- Utilizes sealed for life ball bearing
- Sample part number: D6-35TE-24NY

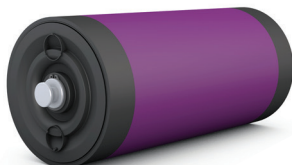

STANDARD ROLL

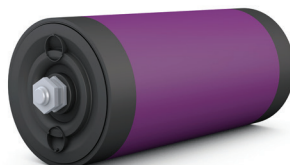

RETRO ROLL

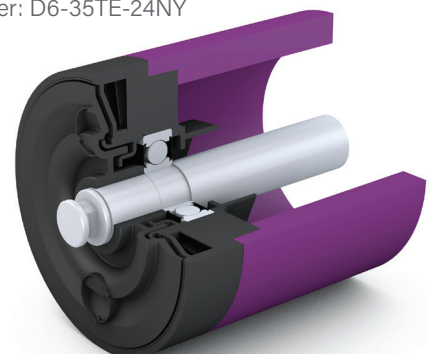

See back for lightweight roll selection guide.

TROUGHING ROLL REFERENCE CHART

MAXIMUM MATERIAL DENSITY FOR ROLL TYPE

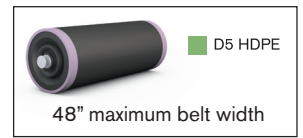
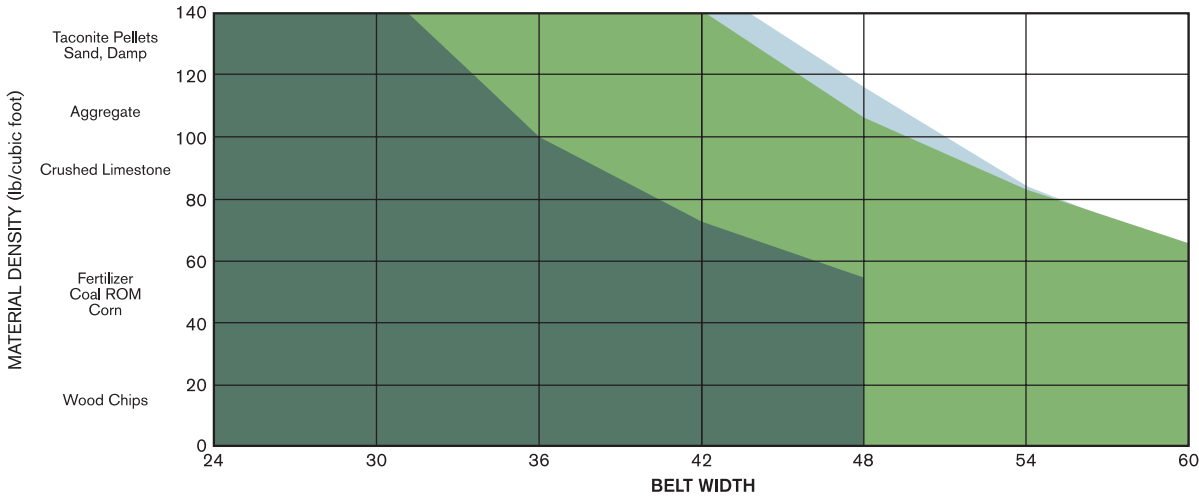

RETURN ROLL REFERENCE CHART

MAXIMUM BELT WEIGHT FOR ROLL TYPE

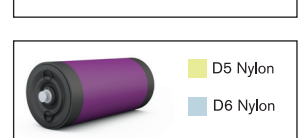
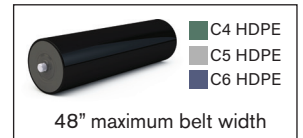
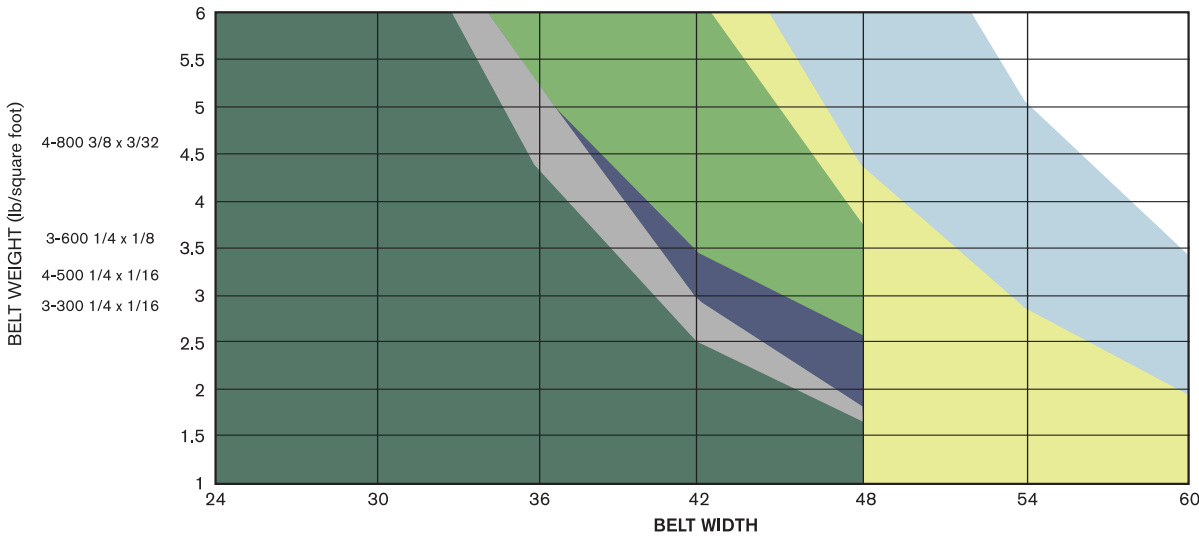

*Charts are given for reference only, exact loading conditions may vary. For loading requirements exceeding chart recommendations please contact PPI engineering for additional solutions. For more information about polymer roll capabilities, please refer to PPI's polymer roll fact sheet, Plastic vs. Steel, found on our website: www.ppi-global.com/resources/catalogs



www.ppi-global.com | sales@ppi-global.com

Product shown are for illustrative purposes only and may display optional accessories or components. Please contact your sales representative for more information on product specifications. PPI respectively reserves the right to make changes in engineering, design and specifications; add improvements; or discontinue manufacturing at any time without notice obligation. PPI and its respective logos are trademarks of Precision, Inc. in the US and/or other countries.