

PPI RETRO ROLL® INSTALLATION INSTRUCTIONS

RETURN COMBO RETRO ROLL® INSTALLATION INSTRUCTIONS

A PPI Retro Roll is a roll that will fit into a non-PPI frame or bracket. PPI makes many rolls with many different shaft ends to fit your needs.

The first step is to identify the CEMA series or bearing size that is needed and which roll end type is needed for your application. If an adapter nut is required, you will need to determine which adapter nut is closest to your existing adapter nut. If there is not an adapter nut or shaft end that fits your needs, fill out the data sheet at the end of this manual and send to PPI. We will help identify which retro roll you need or create a shaft end that will work in your application.

Figure 1 shows some of the most common shaft types B, D, E, F, G, H, and J. There are many more shaft types, and for a more complete list see figure 4 at the end of this Operation and Maintenance Manual.

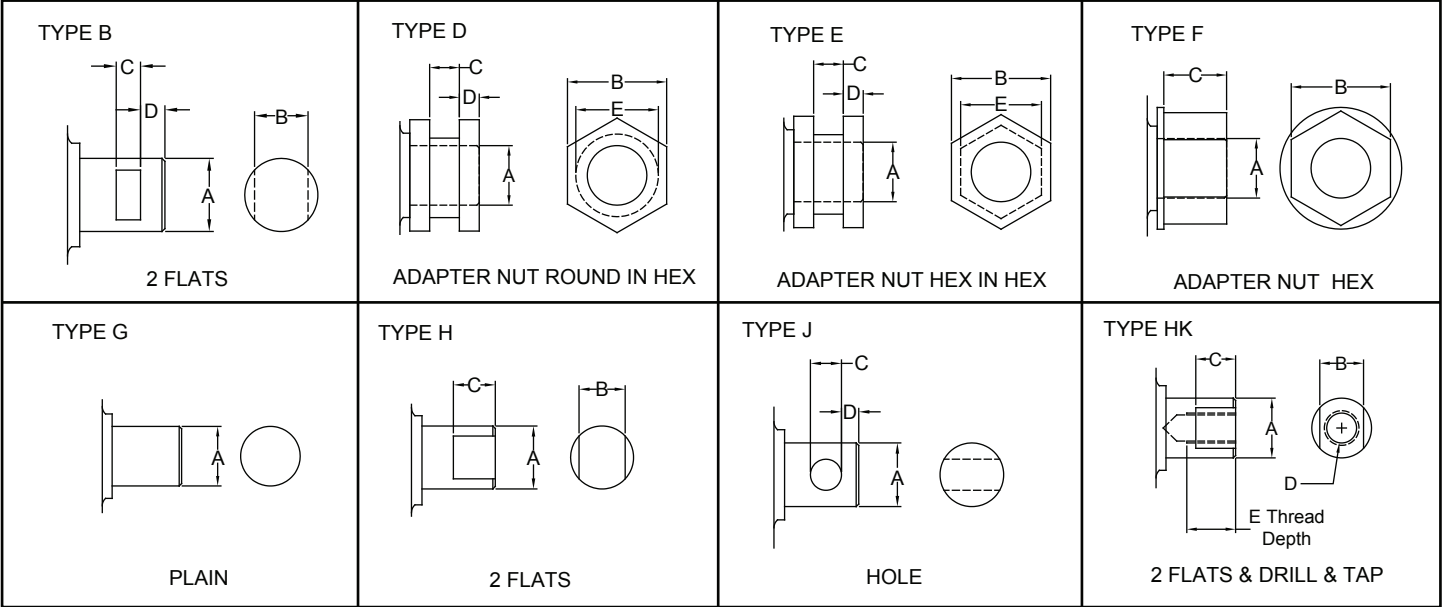

Figure 1

If your roll has an adapter nut, figure 2 will help determine which PPI adapter nut is closest to the adapter nut for your application. Figure 2 shows the correct orientation for the adapter nut to fit in various frames and brackets. For a list of Retro Roll part numbers, see PPI Retro Roll catalog.

Each adapter has 2 basic distinguishing characteristics: the first is the overall size; the second is the shape of the recess or flats. Some zinc adapter nuts have a compound shape in the recessed area. For example, one half of the recess is round and one half is hex. This is so the same adapter nut can fit more than one frame type. The adapter nuts must be positioned so the hex and recess are aligned. The zinc nuts, with the compound shape, have 4 dots on the face of the nut to show the pattern. These dots must be aligned.

When a Retro Roll with adapter nuts is ordered from PPI, the adapter nuts will be installed on the roll and held in place with thread locking compound. The adapter nuts are threaded to facilitate adjustments in the field. If needed the adapter nut location can be adjusted to help fit into a used, worn or bent frames or brackets.

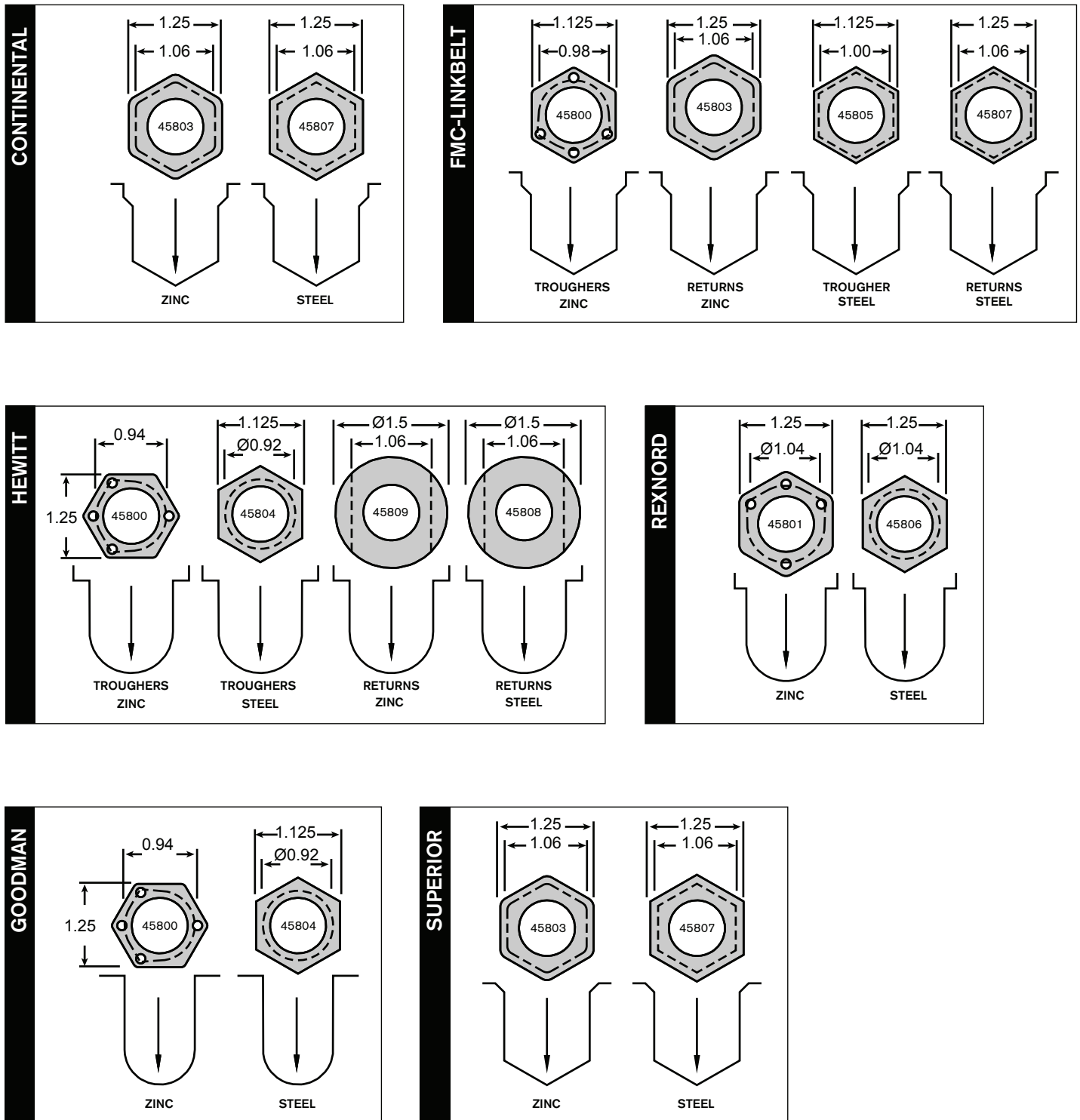

Figure 2

RETURN COMBO RETRO ROLL:

A PPI Return Combo Retro Roll is a roll that will fit in PPI drop brackets and other manufacturers drop brackets. PPI has accomplished this by creating a shaft end with flats to fit PPI drop brackets and by adding an adapter nut the same roll can fit into other manufacturers drop brackets.

The first step for installing a PPI Return Combo Retro Roll is to identify which adapter nut is required. If the Return Combo Retro Roll is shipped without the adapter nut, then when the adapter nut is installed it must be secured in place using a commercial thread locking compound before placing roll-in operation. Failure to do so will void warranty. When installing the adapter nut the thinner side of the adapter nut goes on the inside or towards the center of the roll as illustrated in figure 3. The adapter nuts must be positioned so the hex and recess are aligned at each end of the roll. The zinc nuts, with the compound shape, have 4 dots on the face of the nut to show the pattern. These dots must be aligned.

For standard Retro Rolls, the nut is installed at the factory. The user should only need to make fine adjustments for variation in frames.

If using the Return Combo Retro Roll in PPI Drop Brackets, no adapter nut is needed. Simply drop the flats on the shaft into the brackets.

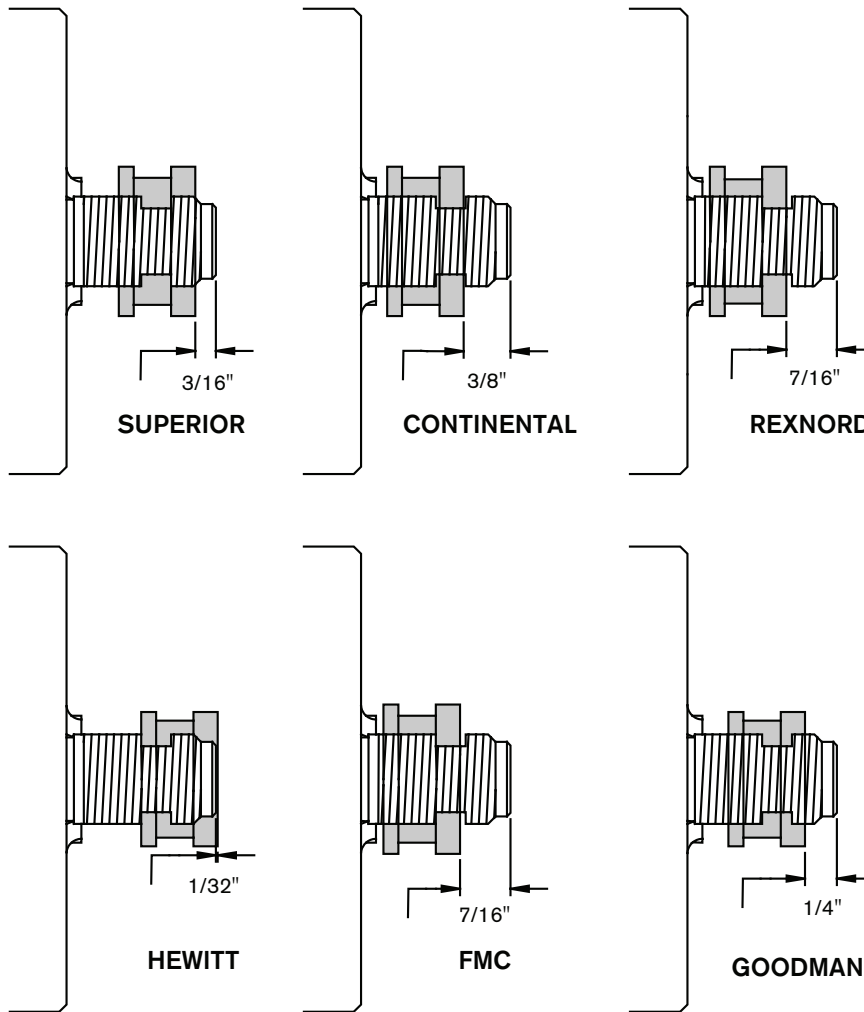

Figure 3

TROUGHING COMBO RETRO ROLL:

PPI does manufacture Combo Retro Rolls for troughers also. The concept is the same as the Return Combo Retro Roll. There are many more dimensions and configurations and therefore not shown in this manual. Contact your PPI representative for more information.

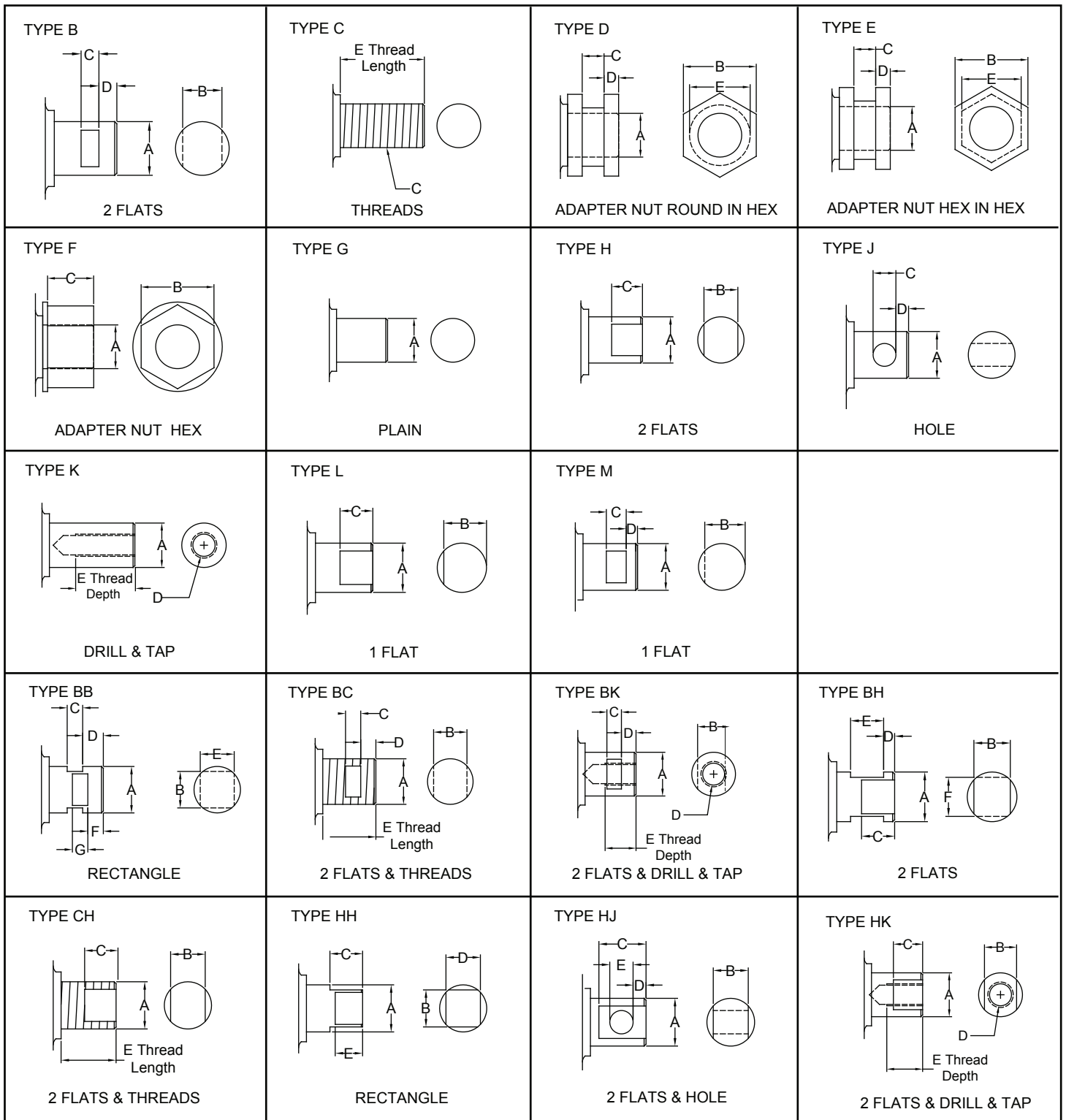
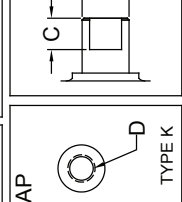
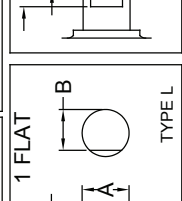
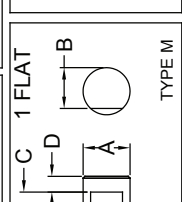
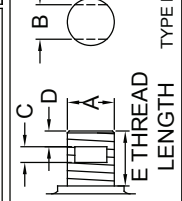
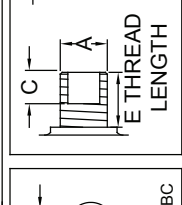
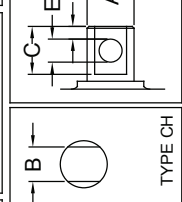
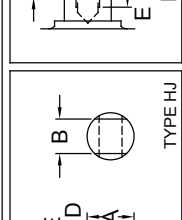
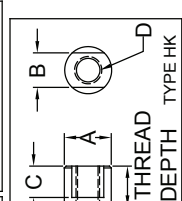
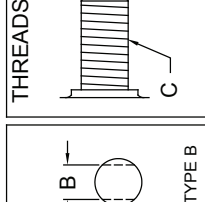
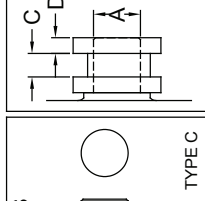
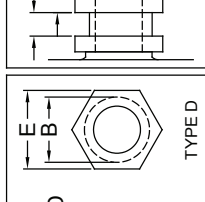
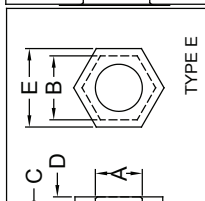
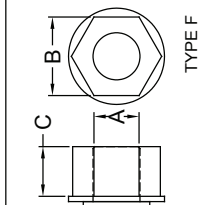
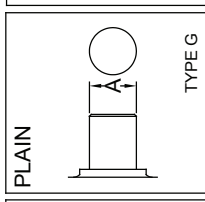
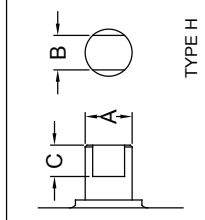
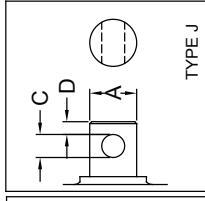
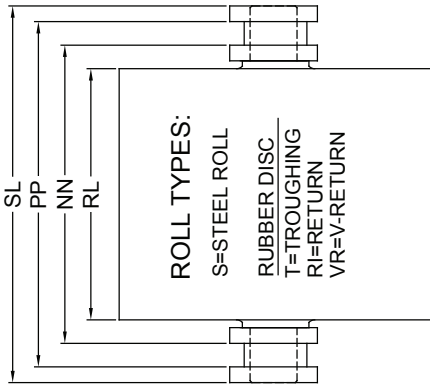

Figure 4



RETRO ROLL DATA SHEET

CUSTOMER _____
 LOCATION _____
 CONTACT _____
 PHONE _____
 FAX _____
 NOTES _____



QTY	ROLL TYPE	SHAFT END TYPE	RD ROLL DIAMETER	RL ROLL LENGTH	SL SHAFT LENGTH	SE SHAFT EXTENSION	NN NUT TO NUT (BRKT TO BRKT)	A SHAFT DIAMETER	AA SHAFT DIAMETER	B ACROSS FLATS	C BROACH NUT WIDTH	D FLANGE WIDTH D&T OR THREAD	E MINOR NUT WIDTH

Tolerances unless otherwise specified	CEMA SERIES	DIAM.	ANGLE	TYPE	BEARING	WEIGHT	ITEM CLASS	SCALE
.0001	N/A	N/A	N/A	N/A	N/A	N/A	N/A	UNK
.0005	ASSEMBLY PART NUMBER							Rev: 6
.0010	PPI RETRO ROLL DATA SHEET							Date: 04/28/14
.0015	ITEM DESCRIPTION							JPM
.0020								BY: EJA
.0025								DATE: 6/17/03
.0030								DWG. NO.: RETROROLLDATASHEET
.0035								PART NO.: N/A
.0040								
.0045								
.0050								
.0055								
.0060								
.0065								
.0070								
.0075								
.0080								
.0085								
.0090								
.0095								
.0100								

