



OPERATION & MAINTENANCE

# BELT CONVEYOR IDLER INSTALLATION INSTRUCTIONS

## IMPORTANT - SAFETY INSTRUCTIONS

Compliance with safety standards, including OSHA and other federal, state and local codes or regulations, is the responsibility of the user of the conveyor installation. Placement of guards and other safety equipment in accordance with safety standards is dependent upon the area and use of the system. A safety study should be made of the conveyor application and guards should be installed wherever appropriate. *Safety Standards for Conveyors and Related Equipment* ANSI B20.1 is a guide for safe construction, installation, operation and maintenance of conveyors and related equipment.

The stated purpose of ANSI Standard B20.1 is to present certain guidelines and safety practices that will assist in establishing a safe work place. It is important to realize that the best design and safety features can be useless in conjunction with faulty maintenance and operating practices.

The broad scope of ASME/ANSI Standard B20.1 precludes its inclusion in this manual. However, it is highly recommended that those responsible for assuring safety in the installation, operation and maintenance of belt conveyors and equipment, acquire and use Standard B20.1 as a reference and guide.

## STORAGE AND PREPARATION

Belt conveyor idlers are usually shipped to the job site mounted on skids. As idlers often arrive well in advance of their installation, they should be stored under cover to protect them from exposure to the weather and other adverse conditions.

Prior to installation, check all idlers for evidence of damage to the rolls or frame due to mishandling. Check all rolls to make sure that they turn freely. Idlers should be cleared of any foreign matter that may have accumulated during transit or storage. Foreign matter on idler rolls can cause damage to the belt.

Reliable operation and long service life of these idlers depends upon the care taken during installation and operation. Periodic inspection and maintenance are required. The following information can be considered to be the minimum care recommended. Local environment, working conditions and regulations may require more frequent servicing.

## ESTABLISHING THE CONVEYOR CENTERLINE

Before proceeding with the installation of the idlers, a centerline of the conveyor must be established. A recommended method is to stretch piano wire the entire length of the conveyor frame or segments of the frame on long conveyors.

1. Anchor the wire at convenient points on the conveyor frame by attaching an eyebolt to a piece of steel.
2. Locate the eyebolt at the center of the conveyor. Remember to keep the eyebolt about 1" to 2" (2.5 cm to 5 cm) above the troughing idlers center roll.
3. Fasten the eyebolt bracket to the conveyor frame.
4. Install a similar eyebolt bracket at the opposite end or at a convenient intermediate point if the conveyor has a bend, slope or curve.

5. String the piano wire, adjust to the centerline of the conveyor, pull the wire taut and secure the wire.

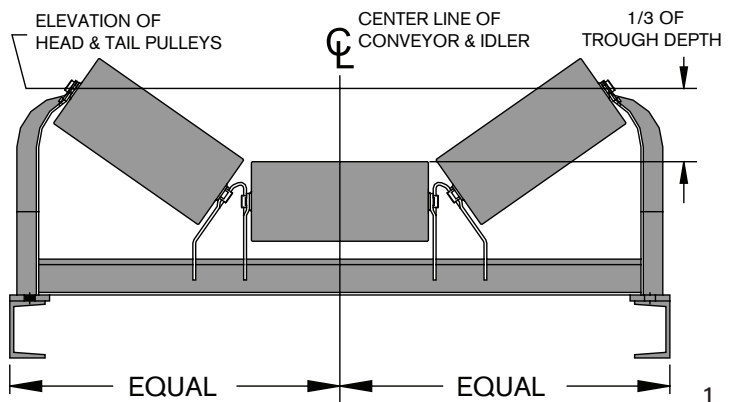

## IDLER INSTALLATION CHECKLIST

Remove mud, stones or any other debris from conveyor stringers and deck plate. Remove all burrs, dents and bumps caused by excessive weld spatter to allow the belt conveyor idler frame to be securely positioned level with the plane of the conveyor and perpendicular to the line of conveyor belt travel.

Rotate each roller to verify that it turns freely. Thoroughly inspect for any blocking or shipping wires that have not been removed. Visually inspect for any shipping or installation damage to the idler frame or rolls.

Check for and remove any tools or other foreign objects on the belt, particularly on the return side where these items may get between the terminal pulleys and belt. Any grease on the belt should be removed immediately as belt deterioration will occur.

- Head and tail shafts need to be parallel to each other.
- All bolts should be properly tightened.
- Troughing idlers

When installing a conveyor system the troughing or carrying idlers should be installed first. Alignment of the structure is critical, if the belt is to train properly on the idlers. Idler and pulley supports must be an equal distance from the conveyor centerline and level across the conveyor width.

When installing troughing idlers, sling the units by their frames. If welding on the conveyor frame is necessary, never ground through a roll as bearing damage may result.

Starting at the tail end of the conveyor, the first standard troughing idler should be located an approximate distance from the centerline of the tail pulley equal to one belt width for 20° troughed idlers, one and one half times belt width for 35 degree troughed idlers and twice the belt width for 45 degree troughed idlers.

It is good practice to use a 20 degree troughing idler as a transition idler for the first and last idler when using 35° troughing idlers and a 35° idler when using 45° troughing idlers.

Place idlers in a position by sliding them in the direction of belt travel until the footpads sit against the mounting bolts.

Tighten bolts by hand. Final alignment requires that the centers of all idlers are in a straight line, perpendicular to the line of belt travel, properly spaced and level. When alignment is complete, tighten all idler mounting bolts securely with a wrench.

Troughing idlers are shipped completely assembled minus the mounting bolts. Four bolts are normally suggested and they must be securely tightened after the idler frame is correctly positioned.

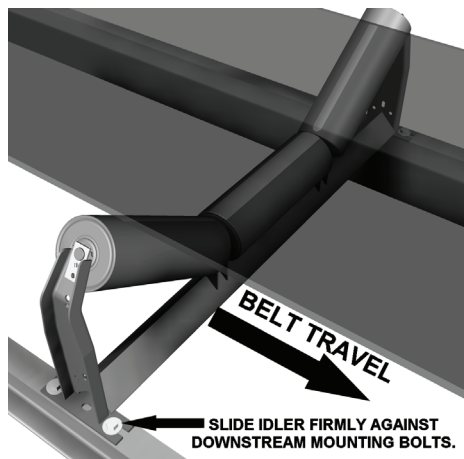

### RETURN IDLERS

After the carrying idlers have been set in place, the return idlers should be installed. The return idlers must be installed perpendicular to the conveyor centerline and level. Leave the training idlers out until the belt has been properly trained.

Hanger brackets and shaft retainer clips are shipped unassembled and without mounting bolts. Normally four mounting bolts are required.

First, install bolt hanger brackets loosely into place below belt conveyor frame side stringer.

Next, insert the roller assembly into the slot of each hanger bracket and allow the shaft slots to sit firmly into the brackets and then attach the clips as detailed below.

The shaft clip slides over the end of the shaft. The holes in the clip and bracket will align when properly installed.

Install self-tapping screw. Do not over tighten.

### SELF-ALIGNING TROUGHING IDLERS

Self-Aligning Idlers are intended to aid in maintaining alignment when conditions such as temporary off-center loading, unusual side winds or misalignment of a transient nature, due to lump concentration, disturbs the alignment of a properly installed conveyor belt. A correctly aligned, loaded, and spliced conveyor belt will not require corrective action from the self-aligning idlers.

Self-Aligning Troughing Idlers are installed along the conveyor length as required, but no closer than 50' (15 m) from a pulley. Positive arm type units are used on belts traveling in one direction only. Actuating type trainers without arms are used on reversing belts and on belts with traveling trippers or stackers.

CEMA B, C, & D Self-Aligners, TESA, RSA, & FSA are shipped completely assembled minus the mounting bolts. Pivot and guide roller bearings are factory lubricated and ready for operation. The guide roller arms are bolted parallel to the frame for shipment.

To set up the frame for operation, remove bolt A at the base of the guide roller arm and reinstall it 90° to the frame. The bolt is designed to insert up from the bottom of the frame. Before tightening the guide arm pivot bolt A, check the alignment of the guide roll with the troughing rolls. With the belt centered, there should be about 1 inch between the guide roll and the belt. The guide roll should be positioned so that it will come in contact with the belt BEFORE the belt can come to the end of the wing roll. Tighten bolt A to 100 ft-lbs.

Carefully check self-aligning idler position to be certain that the guide roller assemblies are properly located so that if the conveyor belt shifts, the belt edges will contact the guide rollers. The guide roller brackets extend in the direction opposite the belt travel. For TESA & FSA, the guide roll arms should be pointing to the tail of the conveyor. For RSA, they should be pointing towards the head of the conveyor.

Place the trainer assembly on the conveyor frame and slide the frame in the direction of belt travel until the footpads seat against the mounting bolts. Remove any blocking or shipping wires so the

trainer frame can pivot freely. Check for squareness and level the trainer frame as required to complete the installation. Verify the type of roll relationship. For example, be sure that both trainer and trougher have the same troughing angle and same belt width.

The Self-Aligning Troughing Idler is designed to provide an elevated roll height as compared to standard troughing idlers. This arrangement provides the greatest training effect, but also increases the load that the frame and rolls have to withstand. The TESA is up to ½" higher than a standard troughing roll.

#### RETURN SELF-ALIGNING IDLERS

Return Self-Aligning Idlers are installed along the length of the conveyor is required, but no closer than 50' (15 m) from a pulley.

They are shipped completely assembled and ready for mounting. Mounting bolts are not supplied. Four bolts are required to secure a training idler.

Return Self-Aligning Idlers have the same features as the self-aligning troughers, with the exception of an elevated roll height.

The Guide Roll Arm Assembly Replacement Part Number for all Self-Aligners is #30145.

#### SIDE GUIDE IDLERS - GRT, GRF, GRR

Side guide idlers do not train a belt but can prevent a belt from running off the pulleys and damage itself against the conveyor structure or other objects.

Side guide idlers should be installed so that they do not touch the edge of the belt when it is running normally. If the belt runs against the side of a guide idler roll continually, even though the rolls rotate freely, wear to the belt edge will occur.

#### SHAFT RETAINING CLIPS

Shaft end clips and center clips are provided to retain the idler roll in brackets. These retaining clips prevent the roll from falling out if the assembly is turned upside or if excessive vibration is present. PPI recommends using retaining clips, but they are generally not required. Retaining clips are always required on any assembly where the roll would fall out without clips, such as the Inverted V-Return.

#### CONVEYOR START-UP

Before actual startup of a conveyor system, electrical controls should be checked to ensure that the entire system can be stopped quickly in case of an emergency.

During initial startup, the conveyor should be jogged on and off until the belt has made several complete revolutions. During this time, make a complete check of all equipment to determine proper adjustment and function.

#### BELT TRAINING

A misaligned conveyor will cause the belt to run-off to one side. The belt will tend to creep to the side that first makes contact with the idler roll. This condition can usually be corrected by adjusting a few idlers to change the contact points.

#### TRAINING AN EMPTY BELT

After the idlers and belt have been installed and before used, the system should be started and checked for alignment. A properly aligned conveyor has the belt running evenly in the center of the idlers and consequently, prevents injury to the belt edges from contact with supporting structures or other objects. If a misalignment problem exists, it is not advisable to attempt correction by readjusting the head or tail pulley because undue strains on the pulleys, bearings, belt, belt splice, joint or the conveyor. Pulleys should be carefully aligned when installed and should not be disturbed for purposes of belt training.

If one section of a belt runs true and another section runs out of line, either the belt is bowed from improper storage, handling or the belt is not properly spliced. If the belt runs out of line consistently at one point in the conveyor, the condition can be attributed to misaligned idlers. Usually the idlers that require adjustment will be located upstream of the point at which the belt runs out of line.

Proper alignment is achieved by loosening the mounting bolts on several idlers on the upstream side and skewing them slightly. When one side of an idler is shifted ahead of the other, the belt shifts to the side that is behind.

See drawing for a visual description. Re-tightening the mounting bolts before restarting the conveyor.

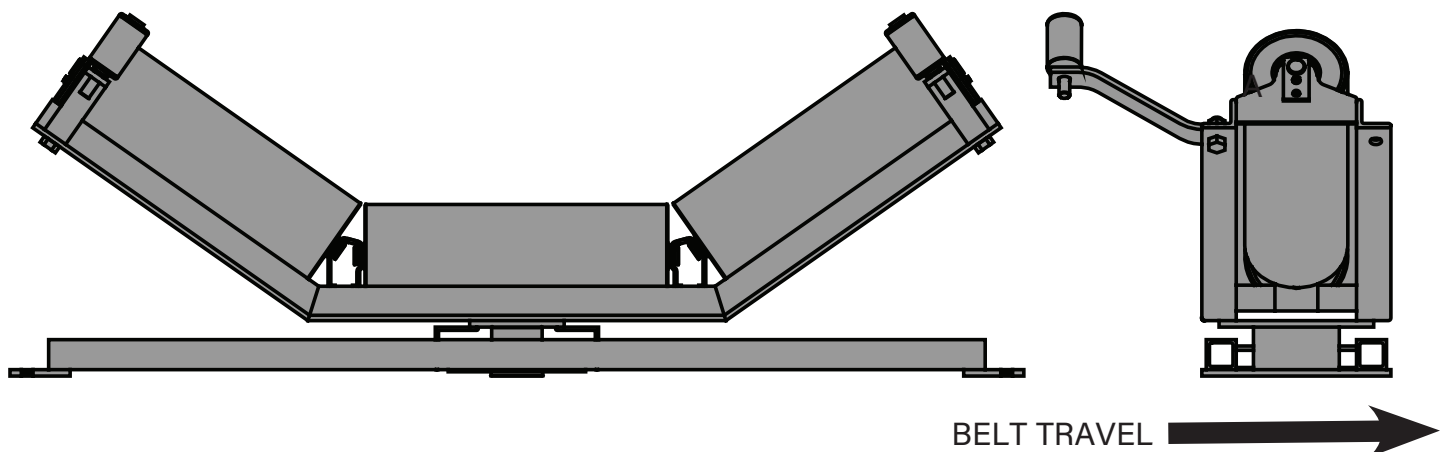

Shifting or tilting of idlers for belt training can be used for belts traveling one direction only. This remedy cannot be used for reversing belt conveyors.

The return side should be adjusted first, starting at the head end. Adjust a few of the preceding idlers at the run-off point if needed. The adjustments are made by shifting the idlers so that the belt contacts the roll opposite the run-off.



TESA as shipped

A slight adjustment on a number of idlers is recommended.

If necessary, repeat this procedure at other points along the belt until the return side is running true.

The carrying side can then be adjusted by using this same procedure starting at the tail end and proceeding to the head end.

Tilting the troughing idlers forward (not over 2°) in the direction of belt travel produces an aligning effect. This may be accomplished by placing a tilting book or steel washer under the rear feet of the idler stand. If the angle of tilt exceeds 2°, excessive wear may occur on the pulley side of the belt and on the troughing rolls themselves, due to the rotation of these rolls on an axis not at the right angle to the path of belt travel. This method has the advantage over shifting idlers and will correct movement on the belt before and after the idler. Consequently, this technique can be useful for training erratic belts. See above.

Return idlers cannot be tilted but by shifting their axis or height, a return idler can provide a corrective effect.

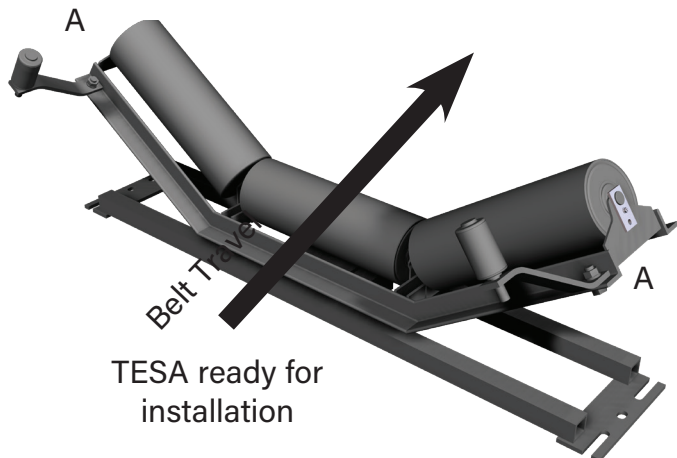

TESA ready for installation

This method of belt adjustment should be done on a temporary basis in cases requiring immediate attention.

Both shifting and tilting idlers are one directional adjustments. They are not effective on a reversible belt.

If the area you are attempting to train continues to be a problem, a self-aligning training idler should be installed just upstream of the problem area.

#### TRAINING LOADED BELT

Once constant central alignment has been achieved on the return and carrying runs with an empty belt, the belt conveyor should be checked while carrying a load.

A properly trained belt will run true under loaded conditions. A loaded belt that runs off-center is usually caused by improper loading. Chutes should distribute the load evenly and on the center of the belt.

Start with a light load and gradually work up to the load the conveyor was designed to handle. Check chutes to see that the material is being directed onto the center of the belt. Off-center loading will affect belt alignment by causing the belt to run off center. A centrally loaded belt will maintain belt alignment.

Angled loading or off-center loading will result in the following conditions.

Off-center or angled loading causes the belt to move laterally on the idlers resulting in spilled material and belt damage.

The loading point of a belt conveyor is the critical point. Here the conveyor belt receives the majority of impacts or abrasions. The ideal solution is to have the material pass from chute to belt with a minimum amount of impact and to load on the center of the belt.

The skirts should be adjusted to prevent spillage of material and to keep the load central on the belt. The maximum distance between skirtboards customarily is two-thirds the width of a troughed belt. It is advisable for centering that when possible the skirtboard distance be reduced to one half the width of the troughed belt, especially for free flowing materials.

When setting the steel for the loading skirts, use a board 3/4" (19 mm) thicker than the belt as a gage for clearance between the idler roll and the bottom of the steel skirting.

After installation of the conveyor belt, install the rubber skirting. The rubber should lay on the conveyor belt with a minimum of pressure.

If continued belt damage is observed from misalignment or from severe impacts from loading material, additional framing or impact, rubber disc idlers should be installed.

#### IDLER MAINTENANCE

All idlers are prelubricated at the factory and are ready for operation. Reliable operation and long service life of PPI idlers depend upon the care taken during installation and operation. Periodic inspection and maintenance are required. Local environment, working conditions and regulations may require more frequent servicing.

A walking inspection of a belt conveyor system is a good method to detect potential problems from any unusual sounds made by such components as idlers, shafts, bearings, rolls or other items.

Excessive build up on idler rolls will cause damage to the belt. Shut down the conveyor, locking out the power switch. Clean up, repair or replace immediately. Review the type of material being conveyed and the type of rolls being used. Rubber disc or polymer coated rolls can reduce or eliminate some roll build-up problems.

PPI idlers are designed to be self-cleaning. Accumulation of material must not interfere with roll rotation or training idlers from pivoting. Clean up any material that could restrict rolls or pivot arms. A stalled roll will cause excessive roll shell and belt wear. Remove and replace any stalled or frozen rolls to prevent belt damage from a worn roll.

At no time should the conveyor idlers be used to handle material loads or speeds other than originally specified. Capacity and belt speed ratings should not be exceeded. Any changes in environmental conditions or conveyed materials should be reviewed for changes in maintenance procedures.

Though impact idlers are designed to minimize belt and roll damage due to impact conditions, the rolls should be observed carefully and may require replacement due to some applications. Reducing idler spacing, grizzlies or stone boxes can further increase idler and belt life in these cases.

Observe the edge of the belt for any wear. If such a condition is observed, locate the area of contact and misalignment and adjust the idlers or install a training idler.

Replace any worn or damaged rolls, rubber discs or any other components not functioning properly.

### **IDLER INSPECTION**

Regularly scheduled inspections of conveyor systems are the best preventative maintenance possible. Problem areas can be detected and corrected before damage occurs to the belt or equipment.

Checking the loading area is the best place to start. Loading chutes should be delivering material to the belt evenly and centered on the belt. Uneven or off-centered loading is the greatest cause of problems on any belt conveyor.

Noticeable vibrations should be located and eliminated as this may loosen mounting bolts and cause the idlers to shift. Misalignment problems must be corrected at once. Check idler alignment and adjust as required. Remember to retighten

mounting bolts. If off-centered loads occur, make corrections to chute work. Watch for unusual wear patterns on the idler rolls, which can be caused by off-centered loading or idler misalignment.

Check for material build-up on idler rolls, particularly the return rolls as these are in direct contact with the carrying side of the belt. If build-up occurs, check the belt cleaner to be sure that it is operating correctly. If a belt cleaner has not been installed, it is recommended that one is placed in operation as soon as possible.

Check all training idlers to see that they are pivoting freely. Remove any accumulated dirt and debris from the frame.

Walk the length of the conveyor installation and verify that the idler rolls are turning freely and smoothly with no excessive endplay.

An inspection maintenance program is essential for low maintenance cost and dependable operation.

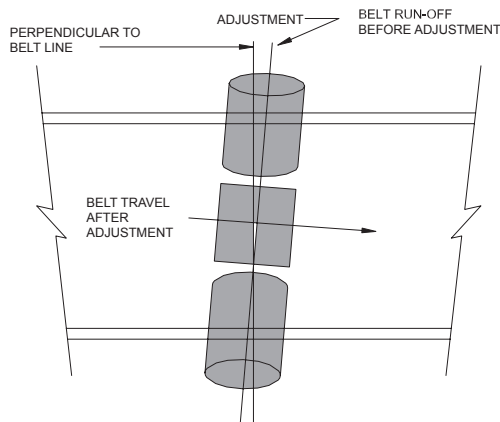
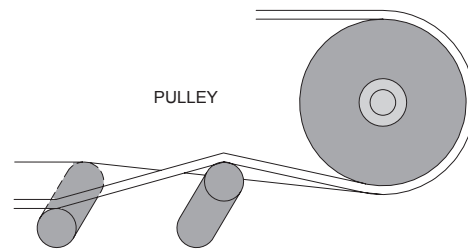
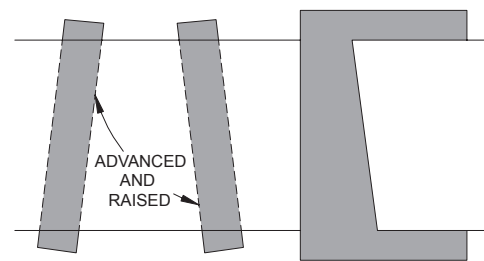

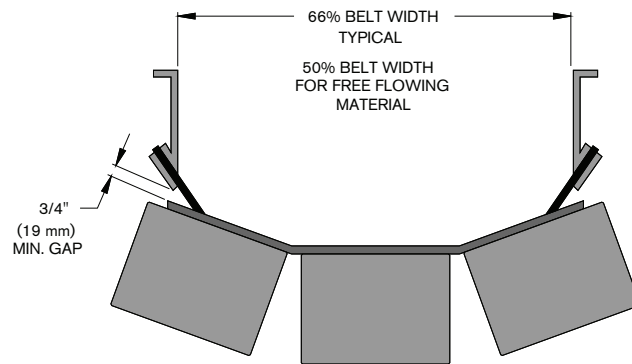
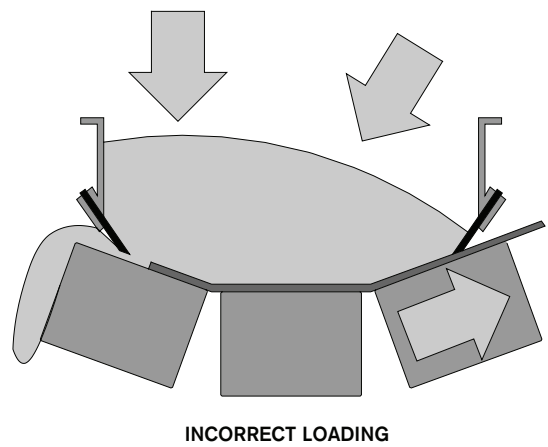
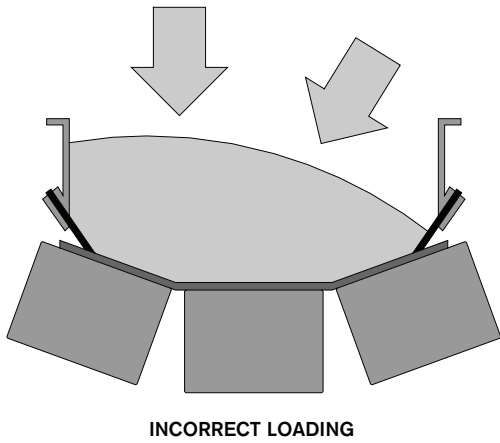
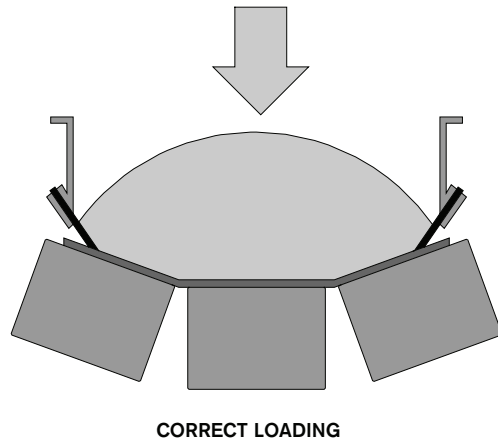
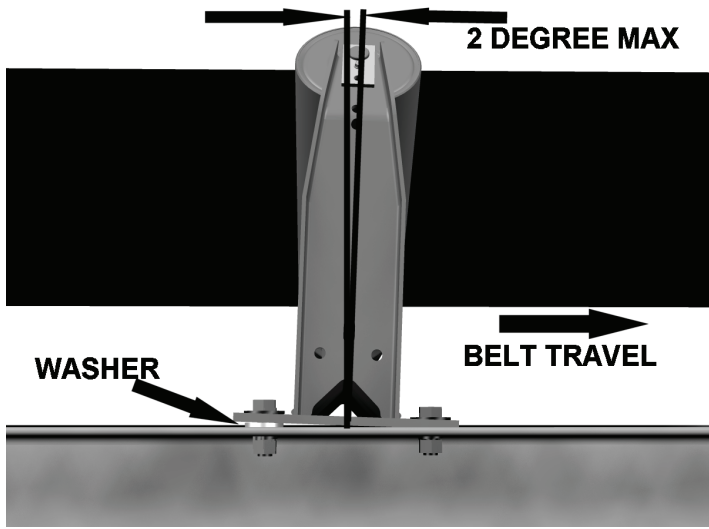

Any belt conveyor installation can be subject to a wide variety of difficulties that may become costly. Those difficulties can result in replacement and plant downtime unless the problem is quickly diagnosed and corrected. This guide is intended to point out the majority of belt conveyor problems and to set forth their probable causes and cures.

## **BELT RUNS OFF TAIL PULLEY**

1. **Counterweight too light:** Recalculate weight and adjust counterweight or take-up accordingly.
2. **Idlers/pulleys not square:** Realign, install limit switches or safety.
3. **Frozen idlers:** Free idlers, lubricate, and improve maintenance.
4. **Spillage at loading point:** Control flow with chutes, feeders, center load.
5. **Material build-up:** Remove accumulation. Install belt cleaners.

## **ENTIRE BELT RUNS OFF AT ALL POINTS OF THE LINE**

1. **Side loading:** Load in center and direction of travel.
2. **Spillage at loading point:** Control flow with chutes, feeders, center load.
3. **Idlers/pulleys not square:** Re-align, install limit switches or safety.
4. **Material build-up:** Remove accumulation. Install belt cleaners.
5. **Belt strained on one side:** Remove strained section and splice in new piece.
6. **Idlers improperly placed:** Relocate or insert additional idlers for support.

## **ONE BELT SECTION RUNS OFF AT ALL POINTS OF THE LINE**

1. **Bad fasteners or splice:** Use correct fasteners; resplice belt.
2. **Edge worn or broken:** Repair belt edge.
3. **Bowed belt:** Avoid telescoping belt rolls or storing in damp locations.

## **BELT RUNS OFF AT HEAD**

1. **Idlers/pulleys not square:** Realign, install limit switches or safety.
2. **Pulley lagging worn:** Replace worn lagging.
3. **Material build-up:** Remove accumulation. Install belt cleaners.
4. **Idlers improperly placed:** Relocate or insert additional idlers for support.

## **BELT RUNS TO ONE SIDE THROUGHOUT ENTIRE LENGTH AT SPECIFIC IDLERS**

1. **Idlers/pulleys not square:** Realign, install limit switches or safety.
2. **Idlers improperly placed:** Relocate or insert additional idlers for support.
3. **Material build-up:** Remove accumulation. Install belt cleaners.

## **BELT SLIP**

1. **Insufficient traction between belt and pulley:** Increase wrap with snub pulleys, lag drive pulley, install belt cleaners.
2. **Counterweight too light:** Recalculate weight and adjust counterweight or take-up accordingly.
3. **Material build-up:** Remove accumulation. Install belt cleaners.
4. **Frozen idlers:** Free idlers, lubricate, and improve maintenance.
5. **Pulley lagging worn:** Replace worn lagging.

*The following causes are listed for each problem in order of probable occurrence and how to correct them. The cures will correct the majority of belt conveyor problems. However, some remedies require lengthy procedures that should be referred to your PPI representative.*

## **BELT SLIP ON STARTING**

1. **Insufficient traction between belt and pulley:** Increase wrap with snub pulleys, lag drive pulleys, install belt cleaners.
2. **Counterweight too light:** Recalculate weight and adjust counterweight or take-up accordingly.
3. **Pulley lagging worn:** Replace worn lagging.
4. **Drive underbeltd:** Recalculate maximum belt tensions and select correct belt.

## **EXCESSIVE BELT STRETCH**

1. **Excessive tension:** Recalculate and adjust tension.
2. **Drive underbeltd:** Recalculate maximum belt tensions and select correct belt.
3. **Material build-up:** Remove accumulation. Install belt cleaner.
4. **Counterweight too heavy:** Recalculate weight and adjust, reduce take-up tension to slip point, and then tighten slightly.
5. **Wrong differential speed:** Make required adjustment.
6. **Damage by abrasives, acid, chemicals, heat, oil, etc.:** Use belt designed for specific conditions, make spot repairs, install rubber disc idlers, do not over lubricate idlers.

## **BELT BREAKS AT OR BEHIND FASTENERS; FASTENERS TEAR LOOSE**

1. **Bad fasteners or splice:** Use correct fasteners; resplice belt.
2. **Pulleys too small:** Use large diameter pulleys.
3. **Excessive tension:** Recalculate and adjust tension.
4. **Pulley lagging worn:** Replace worn lagging.
5. **Material between belt/pulley:** Use skirtboards, remove accumulation, improve maintenance.
6. **Drive underbeltd:** Recalculate maximum belt tensions and select correct belt.

## **VULCANIZED SPLICE SEPARATION**

1. **Excessive tension:** Recalculate and adjust tension.
2. **Pulleys too small:** Use larger diameter pulleys.
3. **Drive underbeltd:** Recalculate maximum belt tensions and select correct belt.
4. **Material between belt/pulley:** Use skirtboards, remove accumulation, improve maintenance.
5. **Bad fasteners or splice:** Use correct fasteners; resplice belt.
6. **Wrong differential speed:** Make required adjustment.

### EXCESS BOTTOM COVER WEAR

1. **Material build-up:** Remove accumulation, install belt cleaner.
2. **Frozen idlers:** Free idlers, lubricate, and improve maintenance.
3. **Breaker strip missing:** When service is lost, install new breaker strip.
4. **Insufficient traction between belt and pulley:** Increase wrap with snub pulleys, lag drive pulley, install belt cleaners.
5. **Material between belt/pulley:** Use skirtboards, remove accumulation, improve maintenance.
6. **Pulley lagging worn:** Replace worn lagging.

### EXCESSIVE EDGE WEAR, BROKEN EDGES

1. **Side loading:** Load in center and in the direction of travel.
2. **Belt strained on one side:** Remove strained section and splice in new piece.
3. **Spillage at loading point:** Control flow with chutes, feeders, center load.
4. **Damage by abrasives, acid, chemicals, heat, oil, etc.:** Use belt designed for specific conditions, make spot repairs, install rubber disc idlers, do not over lubricate idlers.
5. **Bowed belt:** Avoid telescoping belt rolls or storing in damp locations.
6. **Material build-up:** Remove accumulation and/or install belt cleaners.

### COVER SWELLS IN SPOTS OR STREAKS

1. **Damage by abrasives, acid, chemicals, heat, oil, etc.:** Use belt designed for specific conditions, make spot repairs, install rubber disc idlers, do not over lubricate idlers.

### BELT HARDENS OR CRACKS

1. **Damage by abrasives, acid, chemicals, heat, oil, etc.:** Use belt designed for specific conditions, make spot repairs, install rubber disc idlers, do not over lubricate idlers.
2. **Pulleys too small:** Use larger diameter pulleys.
3. **Pulley lagging worn:** Replace worn lagging.
4. **Improper storage/handling:** Refer to your PPI representative for methods.

### EXCESSIVE WEAR, INCLUDING RIPS, GOUGES, RUPTURES AND TEARS

1. **Extreme material impact:** Use correctly designed chutes or baffles, install impact idlers, adjust skirting, load fines first.
2. **Relative loading velocity too high or low:** Adjust chutes or speed.
3. **Spillage at loading point:** Control flow with chutes, feeders, center load.
4. **Material build-up:** Remove accumulation and/or install belt cleaners.
5. **Damage by abrasives, acid, chemicals, heat, oil, etc.:** Use belt designed for specific conditions, make spot repairs, install rubber disc idlers, do not over lubricate idlers.

6. **Breaker strip missing:** When service is lost, install new breaker strip.

### COVERS BECOME CHECKED OR BRITTLE

1. **Damage by abrasives, acid, chemicals, heat, oil, etc.:** Use belt designed for specific conditions, make spot repairs, install rubber disc idlers, do not over lubricate idlers.
2. **Improper storage/handling:** Refer to your PPI representative for methods.

### LONGITUDINAL GROOVING OR CRACKING OF TOP COVER

1. **Skirting rubbing belt:** Install skirting correctly.
2. **Frozen idlers:** Free idlers, lubricate, improve maintenance.
3. **Material build-up:** Remove accumulation and/or install belt cleaners.
4. **Extreme material impact:** Use correctly designed chutes or baffles, install impact idlers, adjust skirting, load fines first.

### LONGITUDINAL GROOVING OR CRACKING OF BOTTOM COVER

1. **Frozen idlers:** Free idlers, lubricate, improve maintenance.
2. **Material build-up:** Remove accumulation and/or install belt cleaners.
3. **Pulley lagging worn:** Replace worn lagging.

### FABRIC DECAY, CARCASS CRACKS, RUPTURES, GOUGES, SOFT SPOTS.

1. **Extreme material impact:** Use correctly designed chutes or baffles, install impact idlers, adjust skirting, load fines first.
2. **Material between belt/pulley:** Use skirtboards, remove accumulation, improve maintenance.
3. **Breaker strip missing:** Install new breaker strip when service is lost.
4. **Driver underbelted:** Recalculate maximum belt tensions and select correct belt.
5. **Damage by abrasives, acid, chemicals, heat, oil, etc.:** Use belt designed for specific conditions, make spot repairs, install rubber disc idlers, do not over lubricate.
6. **Radius of convex vertical curve too small:** Increase radius by vertical realignment of idler to prevent excessive edge tension.

### PLY SEPARATION.

1. **Excessive tensions:** Recalculate and adjust tension.
2. **Pulleys too small:** Use larger diameter pulleys.
3. **Edge worn or broken:** Repair belt edge.
4. **Damage by abrasives, acid, chemicals, heat, oil, etc.:** Use belt designed for specific conditions, make spot repairs, install rubber disc idlers, do not over lubricate.
5. **Belt speed too fast:** Reduce belt speed.



CORPORATE OFFICE • P.O. Box 287 • Pella, IA 50219  
800.247.1228 • 641.628.3115 • 641.628.3658 FAX